



US00D413995S

United States Patent [19]

[11] **Patent Number: Des. 413,995**

Lee et al.

[45] **Date of Patent: ** Sep. 14, 1999**

[54] **YOKE ASSEMBLY FOR ADJUSTABLE LUMINAIRE**

5,176,442 1/1993 Richardson 362/269 X

[75] Inventors: **Brad Lee**, Grand Prairie; **Breck M. Outland**, Dallas; **Timothy W. Terleski**; **Staci A. Mininger**, both of Garland, all of Tex.

Primary Examiner—Susan J. Lucas
Attorney, Agent, or Firm—Hughes & Luce, L.L.P.

[73] Assignee: **Vari-Lite, Inc.**, Dallas, Tex.

[57] **CLAIM**

The ornamental design for a yoke assembly for adjustable luminaire, as shown and described.

[**] Term: **14 Years**

DESCRIPTION

[21] Appl. No.: **29/077,239**

[22] Filed: **Sep. 30, 1997**

[51] **LOC (6) Cl.** **26-05**

[52] **U.S. Cl.** **D26/63; D26/140**

[58] **Field of Search** D26/60, 61, 63, D26/65, 145, 140; 362/267, 269, 275, 285, 287, 418, 419, 427, 147

FIG. 1 is a perspective view of a yoke assembly for adjustable luminaire showing the front, top, and side thereof; FIG. 2 is a front view thereof, the rear view being identical; FIG. 3 is a side view thereof, the other side being identical; FIG. 4 is a top view thereof; FIG. 5 is a bottom view thereof; and, FIG. 6 is a perspective view of a yoke assembly for adjustable luminaire showing the front, top, and side thereof, illustratively showing a luminaire mounted therein.

[56] **References Cited**

U.S. PATENT DOCUMENTS

4,556,936 12/1985 Snow 362/269 X

1 Claim, 3 Drawing Sheets

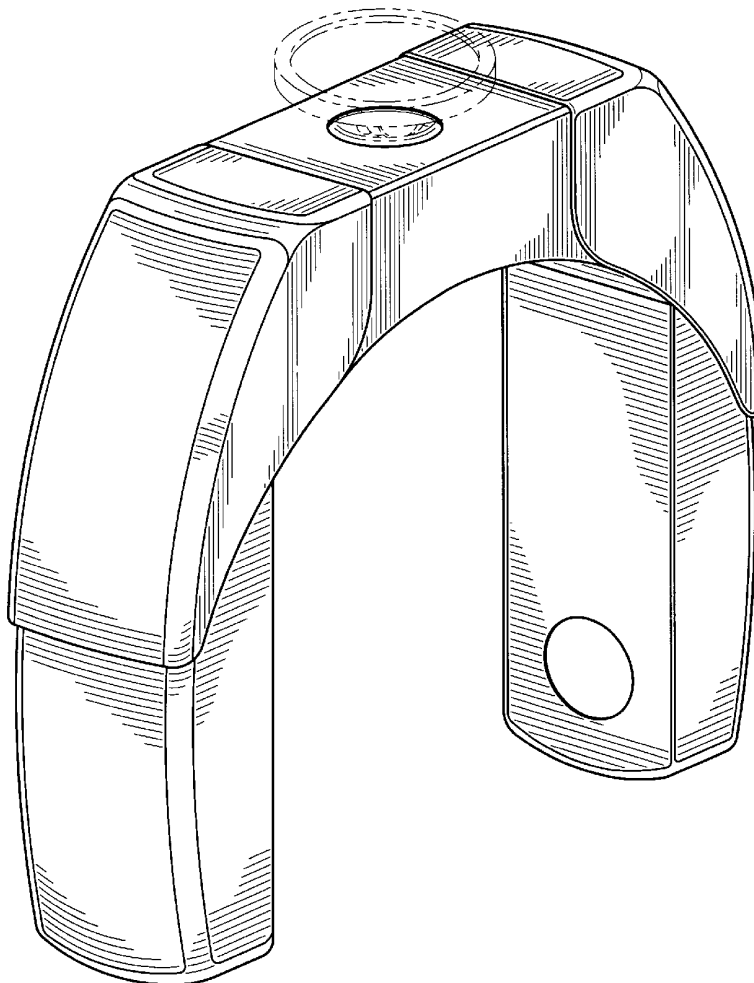

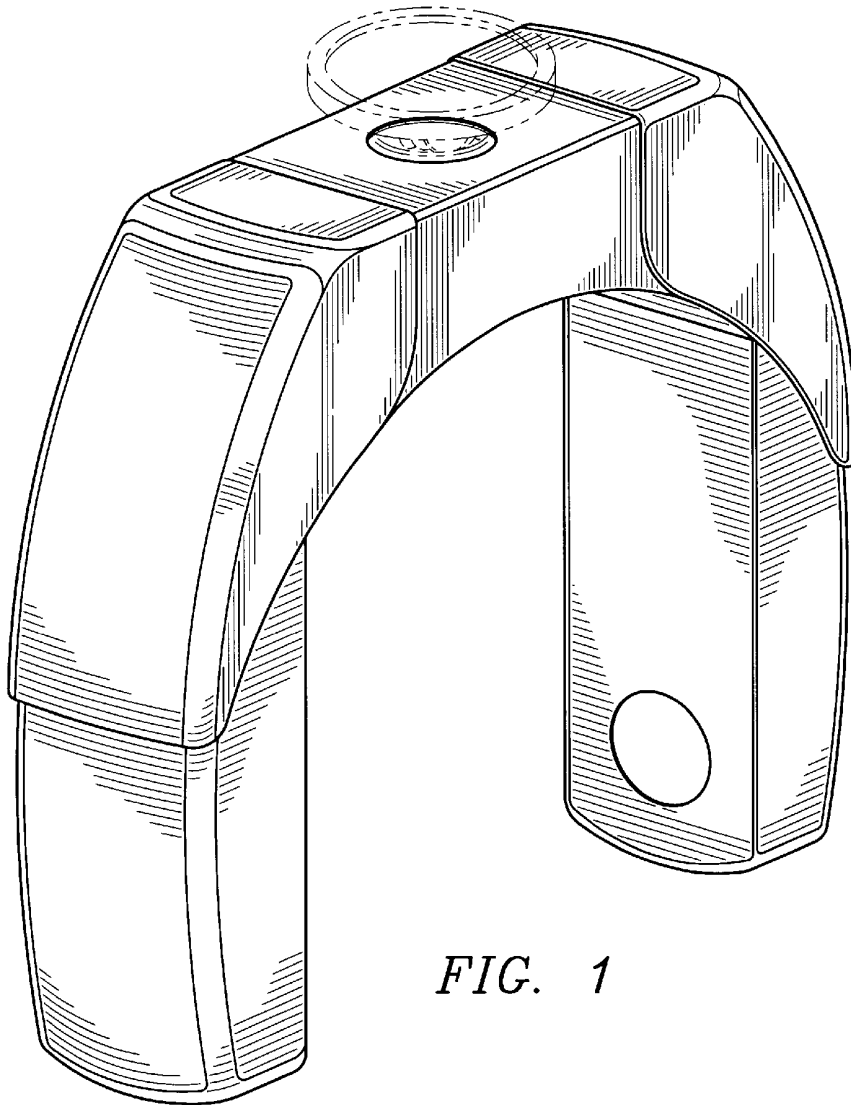

FIG. 1

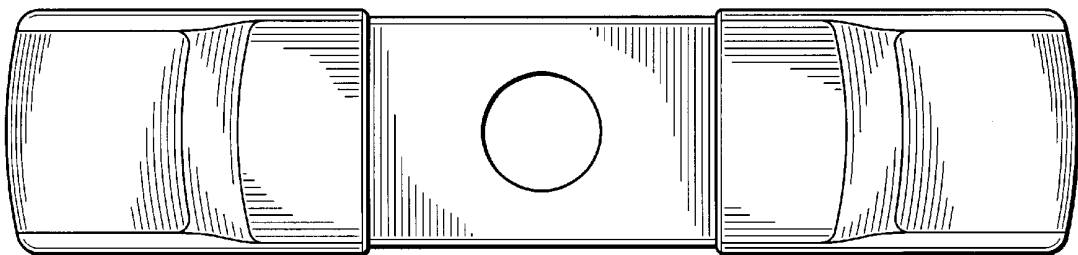

FIG. 4

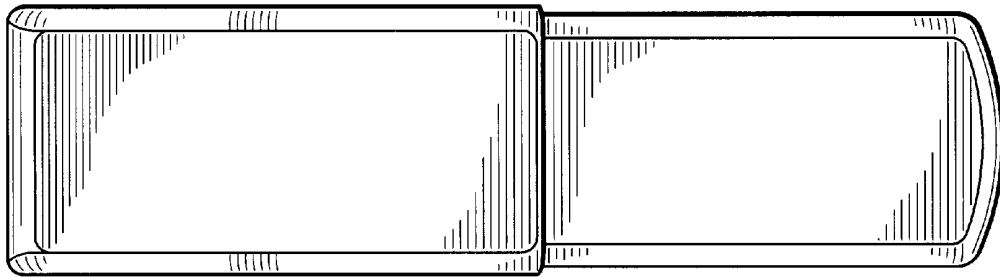

FIG. 3

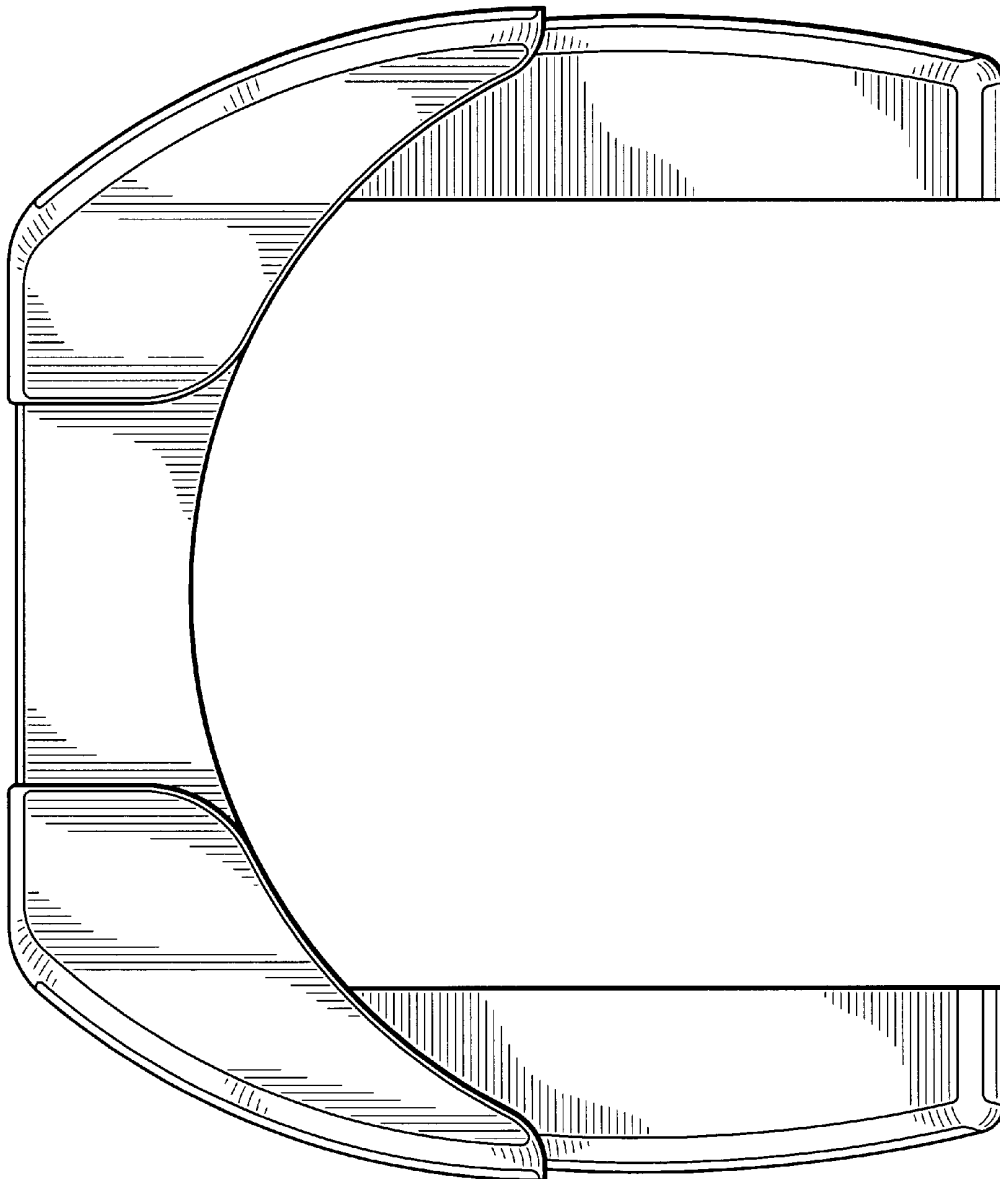

FIG. 2

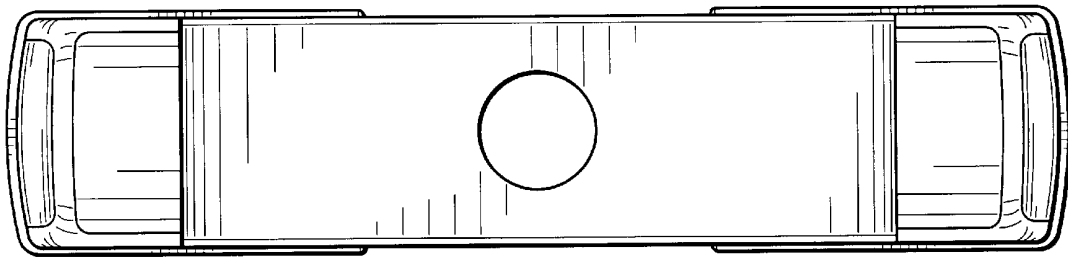

FIG. 5

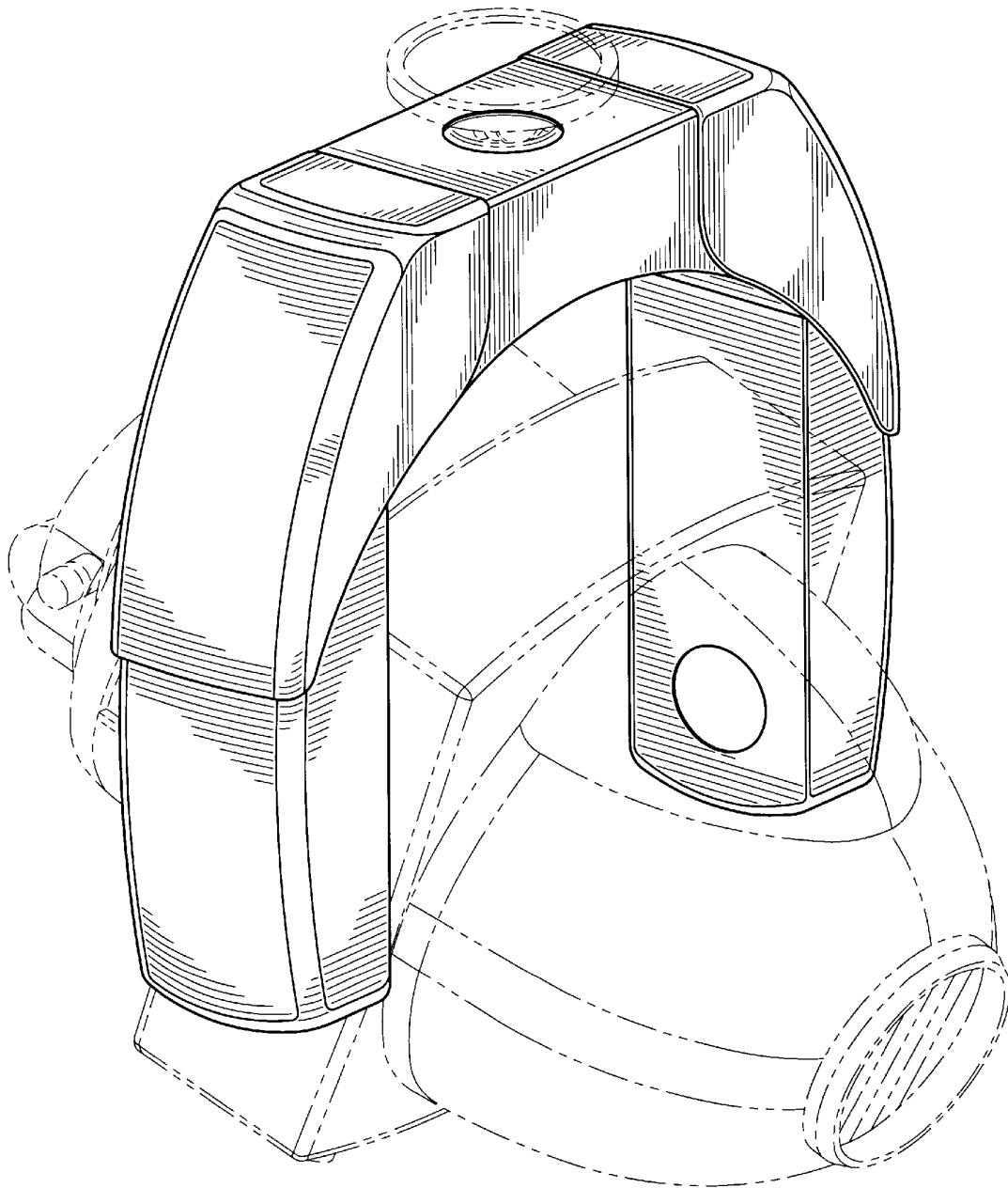

FIG. 6