



US006827451B2

(12) **United States Patent**  
**Belliveau**

(10) **Patent No.:** **US 6,827,451 B2**  
(45) **Date of Patent:** **\*Dec. 7, 2004**

(54) **MULTIPLE LIGHT VALVE LIGHTING  
DEVICE OR APPARATUS WITH WIDE  
COLOR PALETTE AND IMPROVED  
CONTRAST RATIO**

(76) **Inventor:** **Richard S. Belliveau**, 10643 Floral  
Park, Austin, TX (US) 78759

(\*) **Notice:** Subject to any disclaimer, the term of this  
patent is extended or adjusted under 35  
U.S.C. 154(b) by 283 days.

This patent is subject to a terminal dis-  
claimer.

(21) **Appl. No.:** **10/438,094**

(22) **Filed:** **May 14, 2003**

(65) **Prior Publication Data**

US 2003/0193653 A1 Oct. 16, 2003

**Related U.S. Application Data**

(63) Continuation of application No. 09/970,845, filed on Oct. 5,  
2001, now Pat. No. 6,575,577.

(51) **Int. Cl.**<sup>7</sup> ..... **G03B 21/20**; G03B 21/14;  
H04N 3/12; H04N 9/12; G02F 1/1335

(52) **U.S. Cl.** ..... **353/31**; 353/30; 353/122;  
353/84; 353/85; 353/88; 353/89; 353/97;  
348/740; 348/742; 348/743; 348/744; 349/5;  
349/7; 349/8; 362/284; 362/257

(58) **Field of Search** ..... 353/30, 31, 122,  
353/84, 85, 88, 89, 97, 34, 37, 81, 121;  
348/740, 742, 743, 744; 349/5, 7, 8, 6;  
362/284, 257, 269, 238, 239, 251, 295

(56) **References Cited**

**U.S. PATENT DOCUMENTS**

4,779,176 A 10/1988 Bornhorst ..... 362/223  
5,113,332 A 5/1992 Richardson ..... 362/282

5,691,886 A \* 11/1997 Stacy ..... 362/283  
5,758,956 A 6/1998 Bornhorst ..... 362/294  
5,828,485 A 10/1998 Hewlett ..... 259/291  
5,967,636 A 10/1999 Stark et al. .... 353/84  
6,220,730 B1 4/2001 Hewlett et al. .... 362/297  
6,309,070 B1 10/2001 Svetliza et al. .... 351/221  
6,359,662 B1 3/2002 Walker ..... 348/743  
6,406,148 B1 6/2002 Marshall et al. .... 353/31  
2002/0080333 A1 6/2002 Lee ..... 353/31  
2002/0176055 A1 11/2002 De Vaan et al. .... 353/31

**FOREIGN PATENT DOCUMENTS**

WO 9818040 4/1998 ..... G02B/27/28

**OTHER PUBLICATIONS**

© 2003 ColorLink Incorporated, 4 pages.  
Catalyst Media in Motion.  
High End Systems Brochure 2001, Lighting Worldwide.  
Cannon LV 7320 Video Projector [Http://www.video-direct.com/canon/mmprojectors/lv7325.html](http://www.video-direct.com/canon/mmprojectors/lv7325.html) Documentation re  
Canon products:LV-7525, LV-7325, and LV-7320.

\* cited by examiner

*Primary Examiner*—Russell Adams  
*Assistant Examiner*—Melissa J. Koval  
(74) *Attorney, Agent, or Firm*—Walter J. Tencza, Jr.

(57) **ABSTRACT**

An apparatus is disclosed comprising a lamp which pro-  
duces a first light which may be a white light; a first light  
valve, a second light valve, a first color separator, and a first  
aperture device. The first color separator receives the white  
light from the lamp, and separates the white light into a first  
color light and a first residual light. The first aperture device  
receives the first color light and the first aperture device can  
be controlled to modify a frequency of the first color light to  
the first light valve. The second light valve receives at least  
a portion of the first residual light. The first aperture device  
could also be controlled to substantially block at least a  
portion of the first color light.

**10 Claims, 11 Drawing Sheets**

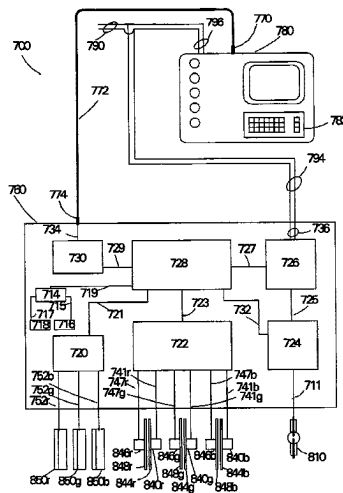
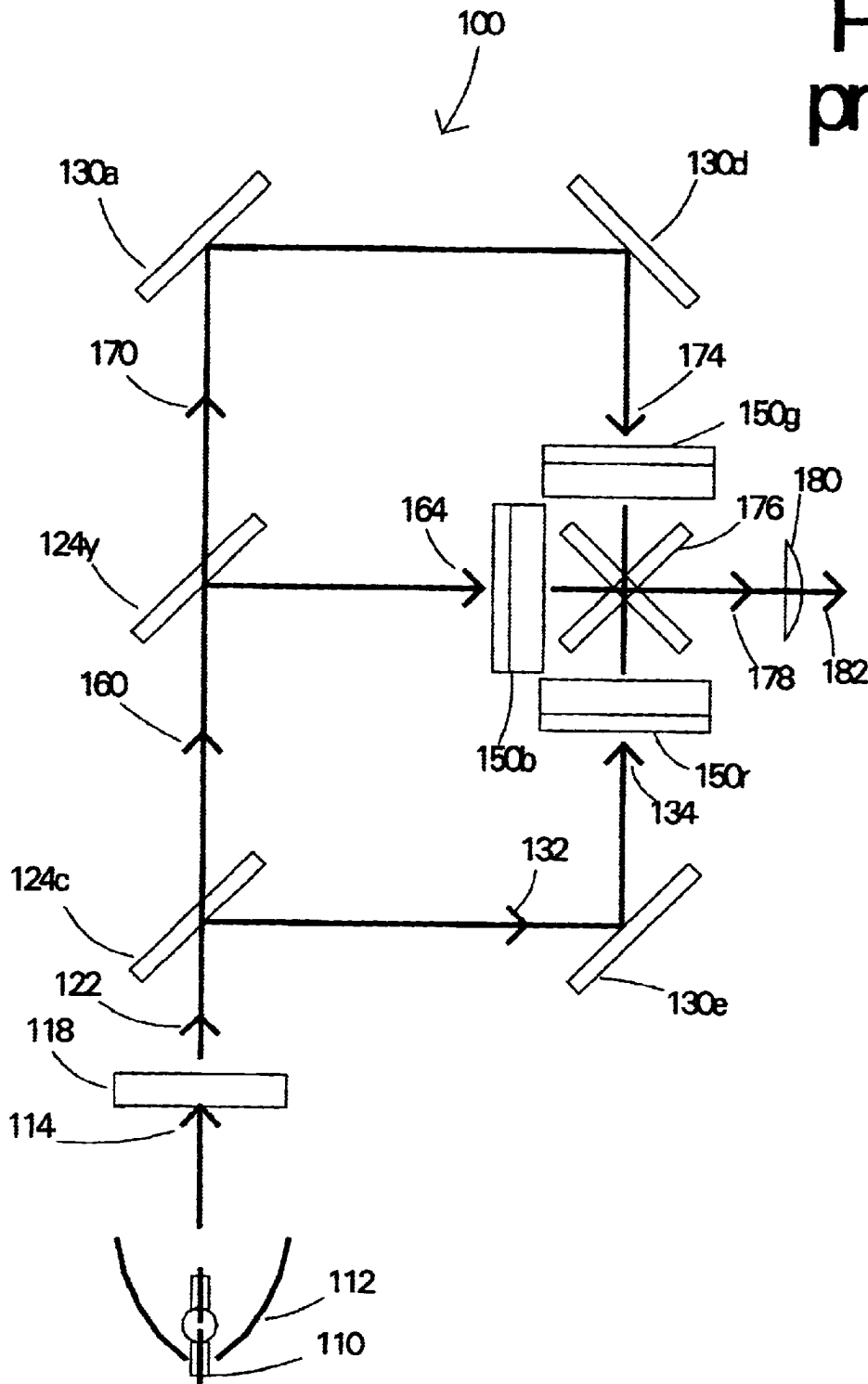
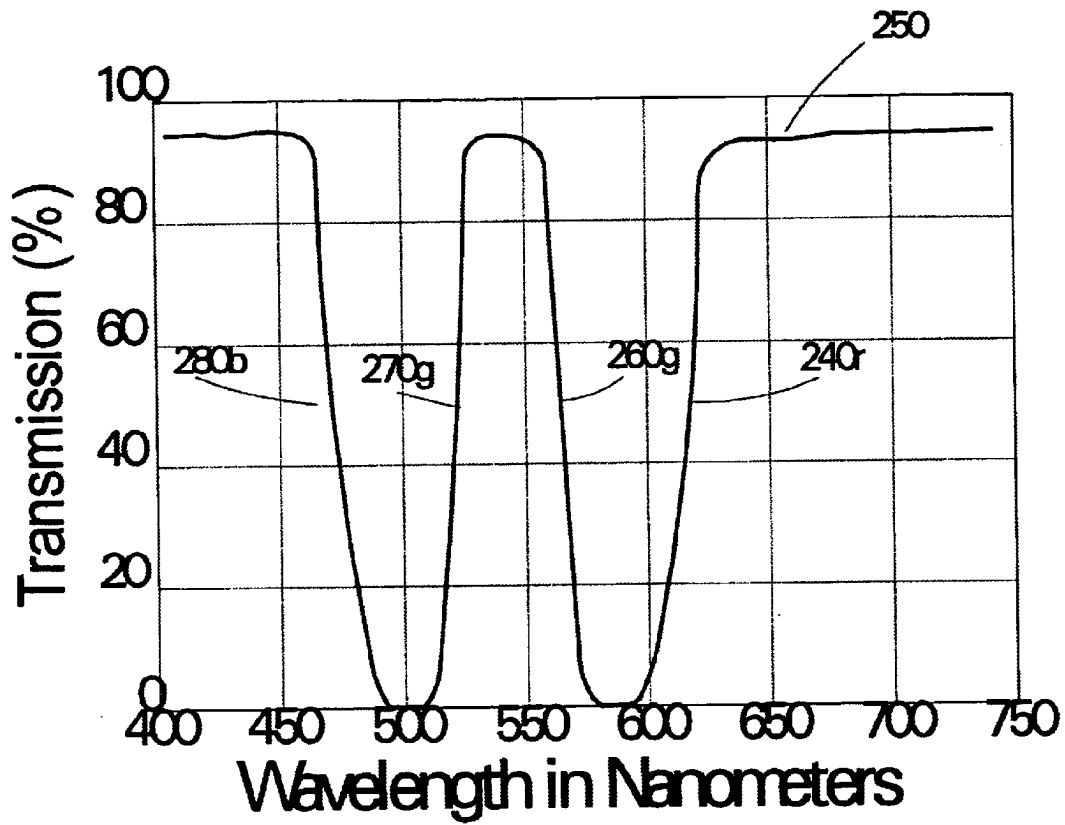

FIG 1  
prior art



# FIG 2 prior art



# FIG 3

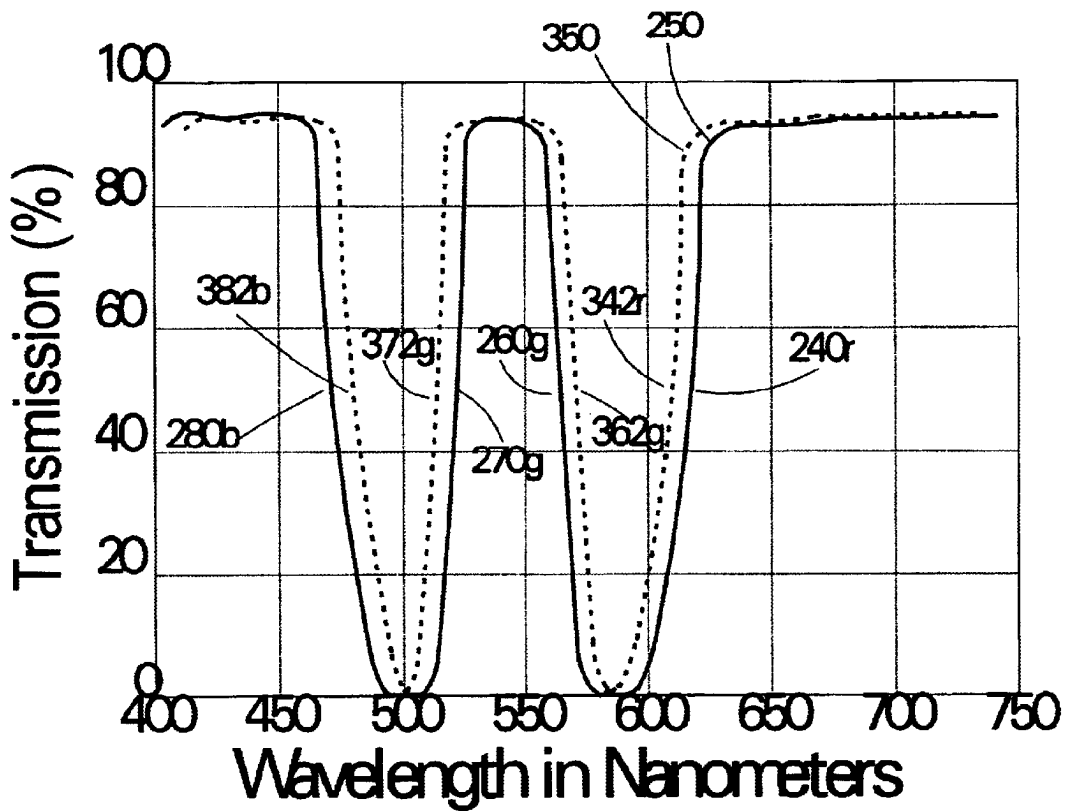
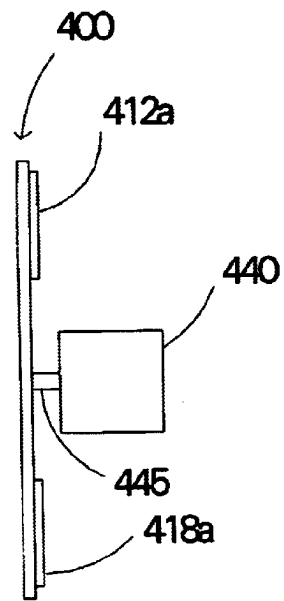
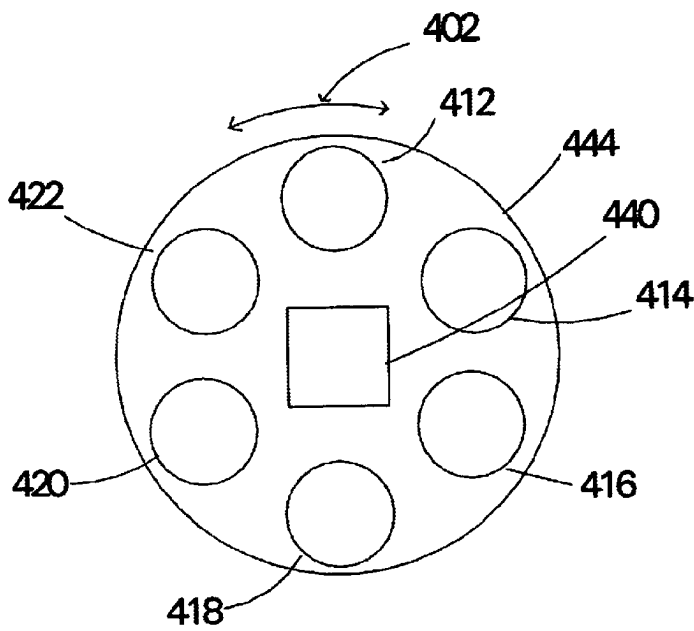

FIG 4A

FIG 4B



# FIG 5

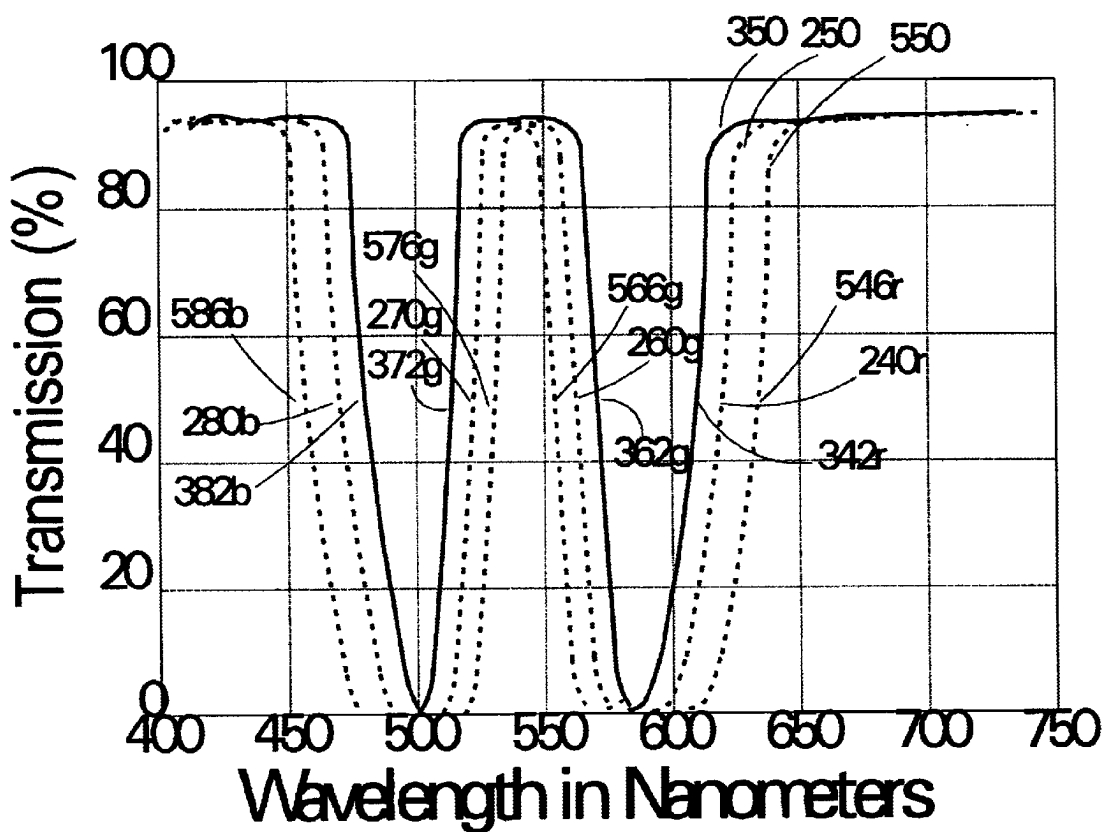

FIG 6A

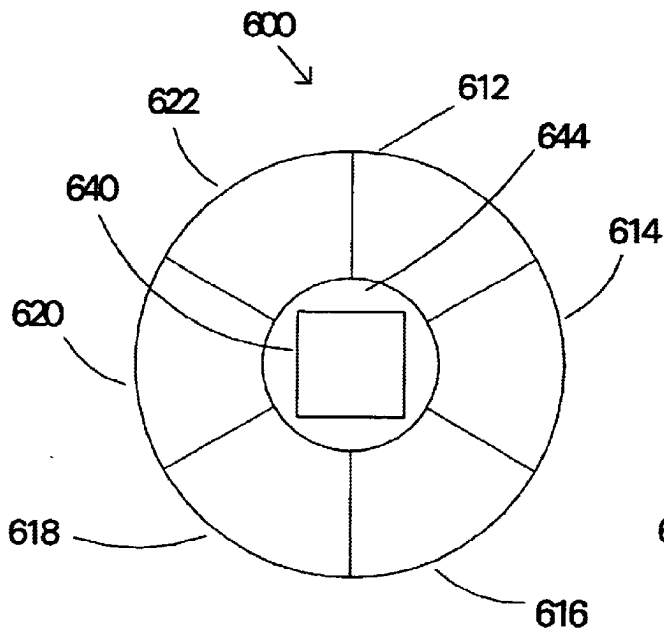
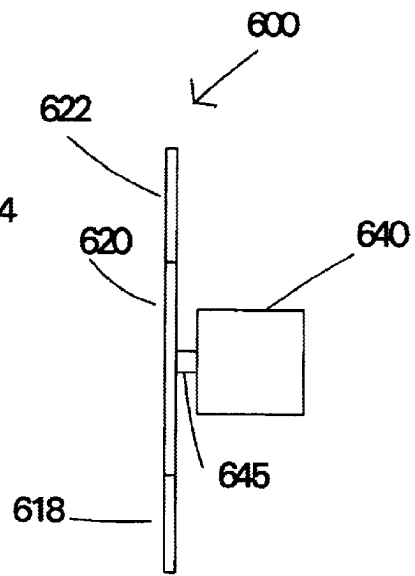
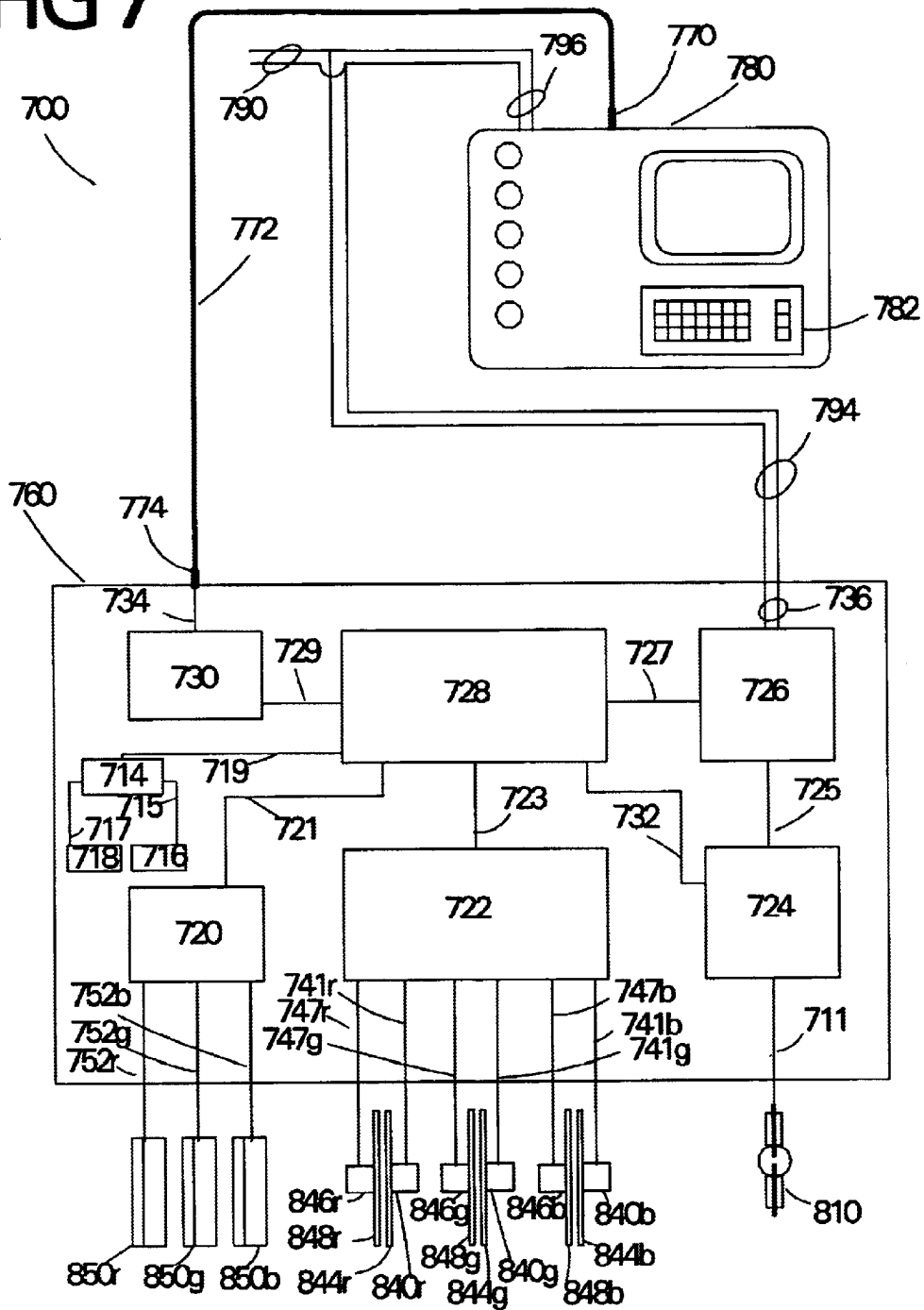

FIG 6B



# FIG 7



# FIG 8

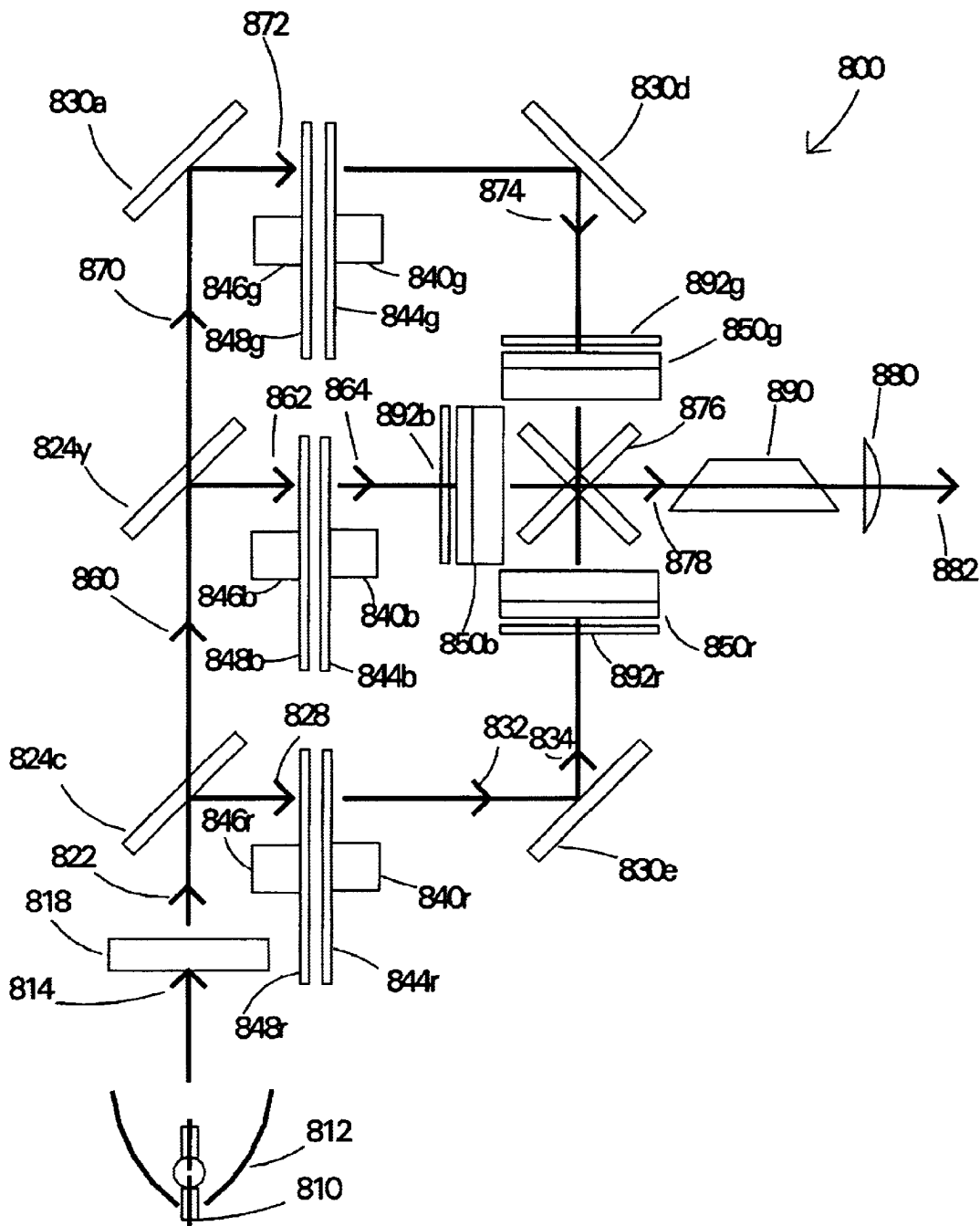

# FIG 9A

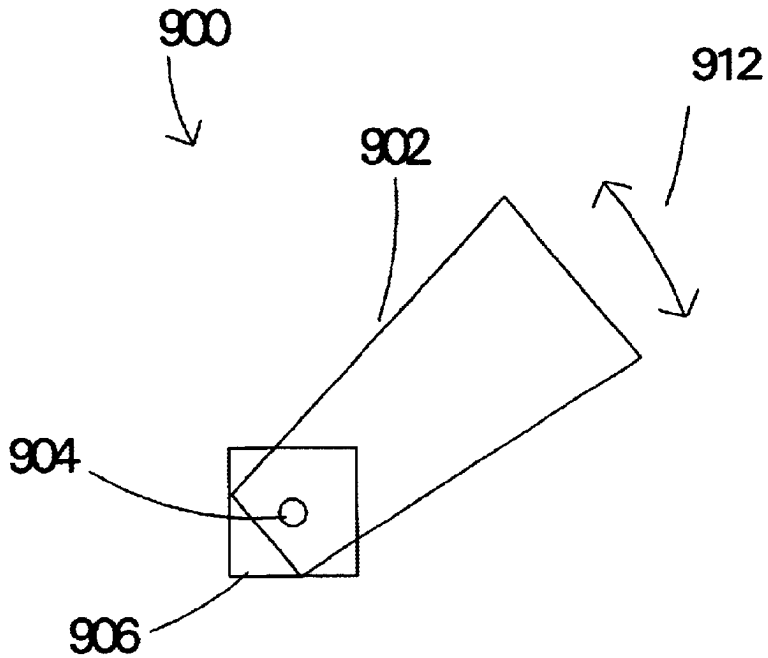

# FIG 9B

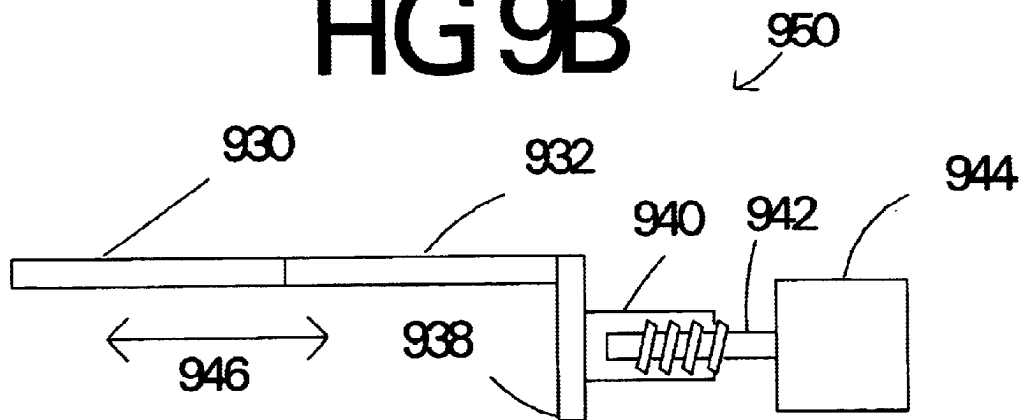

# FIG 10

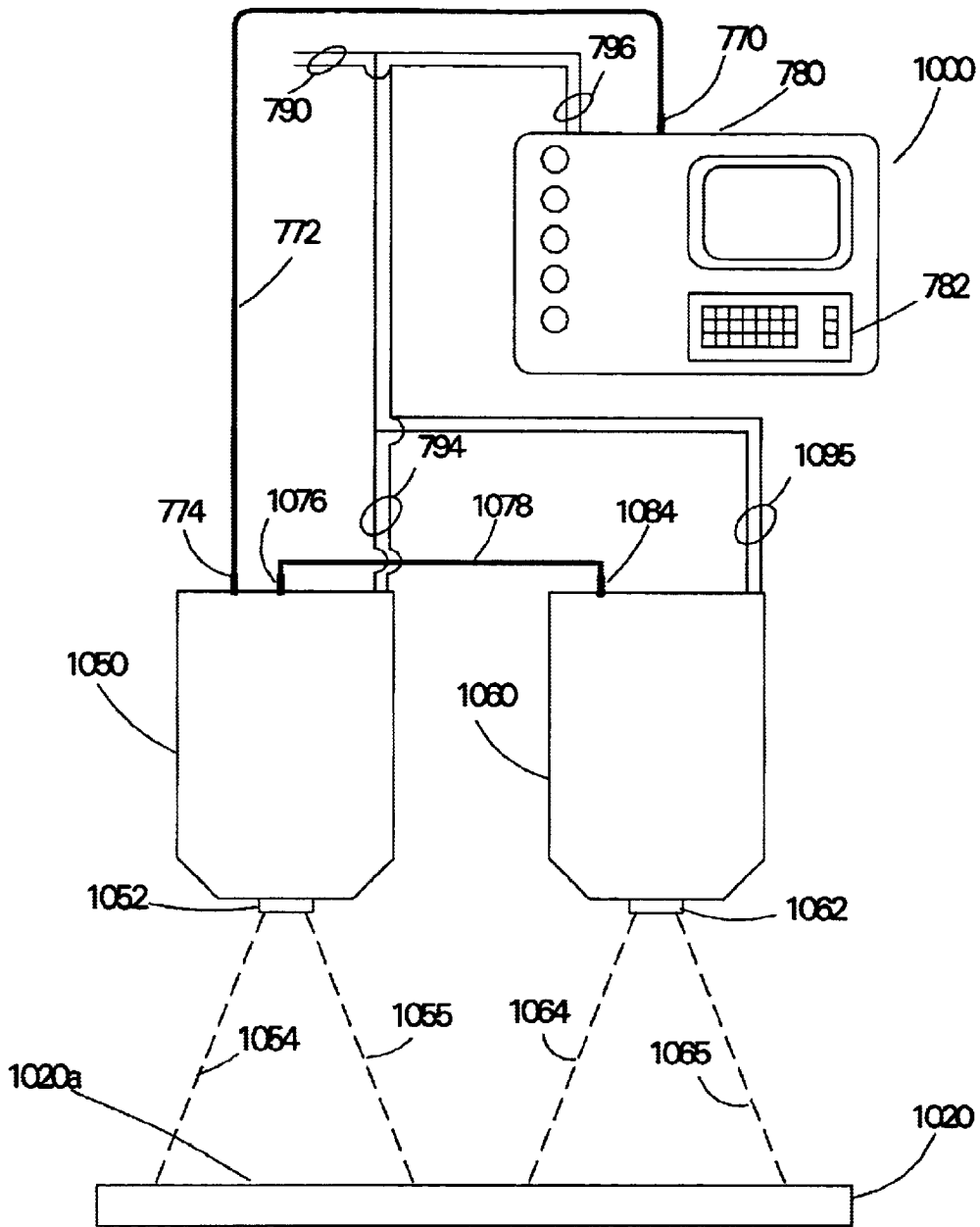
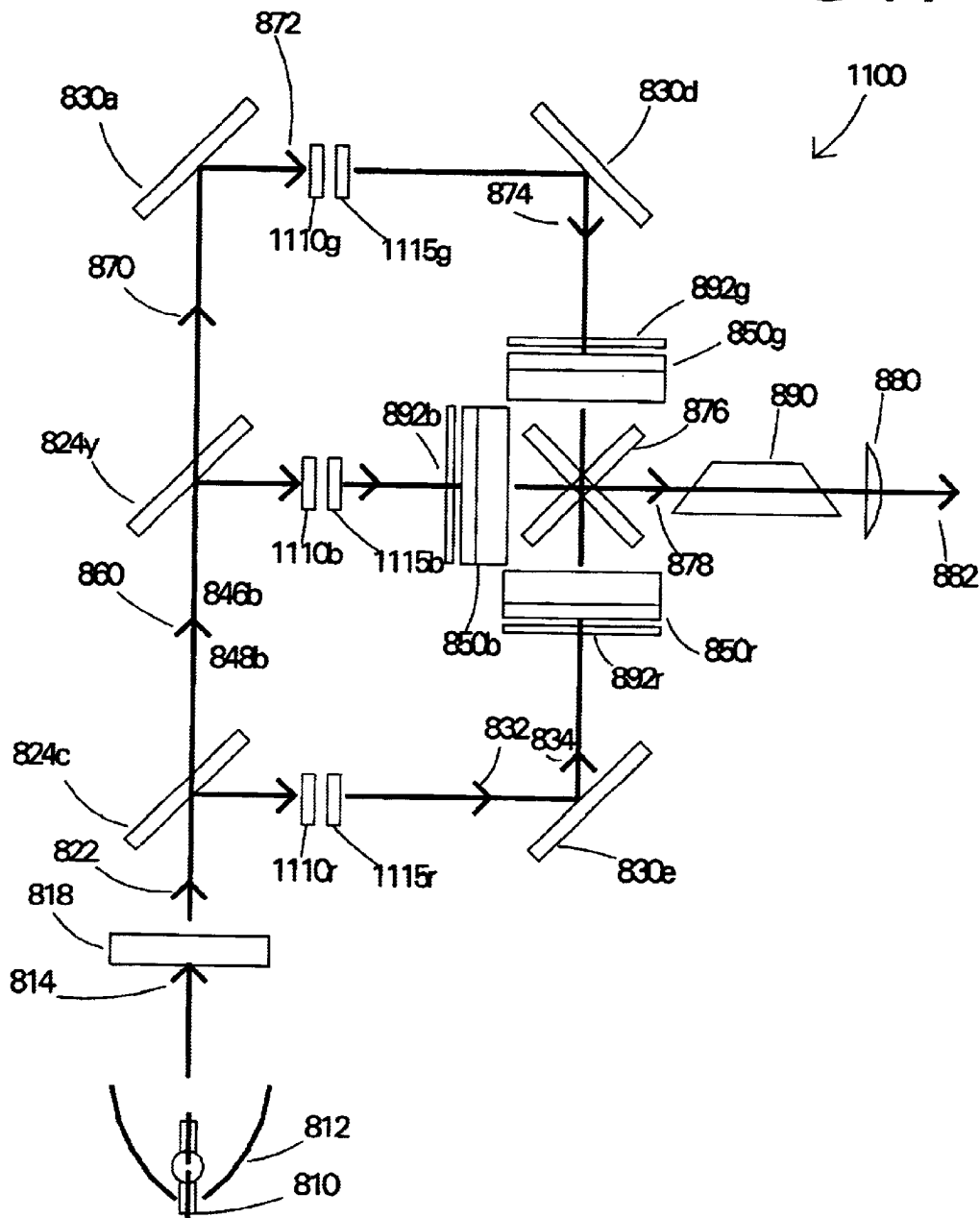

FIG 11



1

**MULTIPLE LIGHT VALVE LIGHTING  
DEVICE OR APPARATUS WITH WIDE  
COLOR PALETTE AND IMPROVED  
CONTRAST RATIO**

This application claims the priority of, and is a continuation of, parent application Ser. No. 09/970,845, titled "MULTIPLE LIGHT VALVE LIGHTING DEVICE OR APPARATUS WITH WIDE COLOR PALETTE AND IMPROVED CONTRAST RATIO", which was filed on Oct. 5, 2001, now U.S. Pat No. 6,575,577.

**FIELD OF THE INVENTION**

The present invention relates to stage lighting devices incorporating light valves for projecting images on a stage.

**BACKGROUND OF THE INVENTION**

Stage lighting devices incorporating light valves for the projection of images are known in the art. Stage lighting devices incorporating light valves are used to project patterns on a stage. Before electronic light valves, stage lighting devices used metal stencil patterns that were indexed on a wheel to produce the projected patterns upon the stage.

U.S. Pat. No. 4,779,176 to Bornhorst titled "Light pattern generator" describes glass substrates with aluminum coatings that are used as projection patterns in a lighting device. U.S. Pat. No. 5,113,332 titled "Selectable mechanical and electronic pattern generating aperture module" to Richardson describes an electronic aperture or light valve used to generate the patterns projected from a lighting device. U.S. Pat. No. 5,758,956 titled "High intensity lighting projectors" to Hutton describes a controllable image quality projection gate providing advanced visual effects. Other types of electronic light valves have also been used with lighting devices. U.S. Pat. No. 5,828,485 titled "Programmable light beam shape altering device using programmable micromirrors" to Hewlett describes a digital micromirror device ("DMD") that is used to alter the shape of light that is projected onto a stage.

The prior art stage lighting devices are designed around a single light valve as the projection gate. The inventors have optimized their inventions to work best as a lighting device. Many inventors prefer the single light valve system as it may have a reduced cost over multiple light valve systems. High End Systems (Trademarked) of Austin, Tex. has found success with a multiple light valve projector in combination with a positioning mirror. The device called a Catalyst (Trademarked) is used like a periscope that mounts to the front of a video projector. It allows static images or moving video to be projected anywhere within a 360° by 180° hemisphere of movement. Images can be manipulated limitlessly in real-time from a dedicated control console. The preferred projector type of the prior art is a three light valve system. More information can be found at: [Http://www.highend.com/pdfbin/NewCatalyst.pdf](http://www.highend.com/pdfbin/NewCatalyst.pdf). The device is limited however as it uses a conventional multiple light valve projection system and can only produce a limited color palette.

In the prior art a single light valve is used. An aperture device containing filters or multiple aperture devices containing filters are located between a lamp producing white light and a single light valve to change the color of the light from the lamp sent to the single light valve. The single light valve systems can not do full color images unless they spin an aperture device containing color filters of red, blue and green in front of the single light valve. The aperture device

2

containing the colors of red, blue and green is rotated, in the prior art, at a certain frequency in sync with the single light valve to produce a full color image. Because each color is only on for a third of the time, much of the energy from the lamp is lost. An example of this technique is shown at <http://howstuffworks.lycos.com/projection-tv5.htm>

With existing regular video projection, three light valves are used with the white light produced from a lamp separated into red, green and blue as more of the light from the lamp is used to produce a full color image

The problem is that for a video projection device built for video the red, green and blue colors are specially selected.

**SUMMARY OF THE INVENTION**

The present invention discloses a lighting device using multiple light valves which provide an improved contrast ratio from devices of the prior art. The lighting devices of embodiments of the present invention are capable of projecting a wide range of available colors.

The present invention allows a greater array of colors both saturated and less saturated to be used by first allowing the widest production of red, green and blue by a color separation system or device and then modifying the colors from the color separation system with aperture devices that contain color filters. Aperture devices modify the separated colors.

It is one object of the present invention to construct a multiple light valve lighting device with an improved lighting color palette.

It is yet another object of the present invention to construct a multiple light valve lighting device with an improved contrast ratio.

It is yet another object of the present invention to transmit commands over a communication system to the multiple light valve lighting devices where custom color palettes may be selected remotely.

It is yet another object of the present invention for the multiple light valve device to automatically improve the contrast ratio based upon the program material.

It is yet another object of the present invention for the multiple light valve lighting device to shutter the outputs of the individual light valves upon a command over the communication system.

It is yet another object of the present invention for the multiple light valve lighting device to shutter all of the individual light valves to produce a black out.

**BRIEF DESCRIPTION OF THE DRAWINGS**

FIG. 1 shows a prior art multiple light valve projector optical system comprised of three light valves;

FIG. 2 is a graph showing the light transmission versus wavelength of the prior art system of FIG. 1;

FIG. 3 is a graph which compares the prior art FIG. 2 light transmission versus wavelength with the light transmission versus wavelength produced by the embodiment of FIG. 8 in accordance with the present invention;

FIG. 4A shows an aperture wheel for use with an embodiment of the present invention, such as FIG. 8, for modifying the bandwidths of red, blue or green light;

FIG. 4B shows a side view of the aperture wheel of FIG. 4A;

FIG. 5 is a graph representing three different slope conditions of light transmission versus wavelength. The first set of slopes corresponds to the FIG. 8 embodiment and is also

3

shown in FIG. 3. The other two sets of slopes can also be obtained by the FIG. 8 embodiment by adjusting the aperture devices;

FIG. 6A shows an aperture wheel for use in the embodiment of FIG. 8, with wedge shaped apertures;

FIG. 6B shows a side view of the aperture wheel of FIG. 6A;

FIG. 7 shows a remote console and a control system for a multiple light valve lighting device in accordance with an embodiment of the present invention;

FIG. 8 shows an optical apparatus of an embodiment of the present invention using three light valves;

FIG. 9A shows an apparatus comprised of a shutter device or a single color filter, a light blocking material, a motor shaft, and a motor which can be used in the embodiment of FIG. 8;

FIG. 9B shows a linear aperture device that can insert apertures into a light path which can be used in the embodiment of FIG. 8;

FIG. 10 shows two multiple light valve lighting devices connected over a communication system to a remote console; and

FIG. 11 shows an apparatus which is basically the same as the apparatus of the embodiment of FIG. 8, except that electronically switchable spectral filters have been substituted for aperture wheels (and their motors).

#### DETAILED DESCRIPTION OF THE DRAWINGS

FIG. 1 shows a prior art multiple light valve projector optical system 100 comprised of light valves 150g, 150r and 150b. The multiple light valve projector optical system 100 is further comprised of a lamp 110, a reflector 112, a polarization converter 118, a color separator 124c, a color separator 124y, reflector 130a, a reflector 130d, a reflector 130e, a color combining system 176, and a focusing lens 180.

The lamp 110 produces a white light whose path is illustrated by arrow 114. The white light or any light of a plurality of frequencies may be considered a first light of a plurality of frequencies within the meaning of various claims of the application. The lamp 110 has its energy focused by the reflector 112. The lamp 110 produces visible white light with the components of red, blue and green wavelengths. The light focused by the reflector 112 as shown by the arrow 114 is directed to the polarization converter 118. The light exits the polarization converter 118 and is directed towards color separator 124c as shown by an arrow 122. Color separator 124c can be a dichroic color separation filter that reflects red light in the direction of an arrow 132 while transmitting blue and green light in the direction of an arrow 160. The action by the color separator 124c can be described as separating the white light into a first color light and a first residual light. The first residual light may be comprised of one or more frequencies and a "portion" of the first residual light may be defined as including one or more frequencies of the one or more frequencies of the first residual light. Similarly a "portion" of any other particular light as referred to in this application, may be comprised of one or more frequencies of the one or more frequencies of that particular light.

The red light as shown by arrow 132 is directed towards the reflector 130e. The reflector 130e reflects the red light in the direction of an arrow 134 towards the light valve 150r. The blue and green light, or first residual light, transmitted by the color separator 124c is directed towards the color

4

separator 124y as shown by an arrow 160. Color separator 124y reflects blue light, which is directed towards the light valve 150b as shown by an arrow 164. Color separator 124y transmits green light towards reflector 130a as shown by an arrow 170. The action by the color separator 124y can be described as separating the first residual light into a second color light and a second residual light. Reflector 130a reflects the green light towards the reflector 130d and the green light is reflected towards the light valve 150g as shown by an arrow 174.

The red, green and blue lights that are received by the light valves 150r, 150g, and 150b, respectively are next directed through their corresponding light valve towards the color combining system 176. The red, green and blue lights are recombined to a common path and are directed towards the focusing lens 180 as shown by an arrow 178. The lens 180 forms an image from the lights which passes through the valves 150r, 150b and 150g and which are combined by combining system 176 and directs the combined light in the direction of an arrow 182 to a projection surface (not shown) where the image from the light valves 150r, 150b, and 150g is projected.

FIG. 2 is a graph showing slopes 250 of light transmission versus wavelength of the prior art system of FIG. 1. The slopes 250 show the transmitted frequencies of light to be combined as the overall available light output at arrow 182. The lamp 110 provides white light, which includes light of a variety of wavelengths. As an example, about ninety percent of a light component in the white light at arrow 114 having a wavelength of 450 nanometers is transmitted through the lens 180 to arrow 182 (minus the normal losses associated with the various optical components), as shown by FIGS. 1 and 2. As another example, about zero percent of a light component in the white light at arrow 114 having a wavelength of 500 nanometers is transmitted through the lens 180 to arrow 182.

The prior art slopes 250 in FIG. 2 shows cutoff points 280b, 270g, 260g, and 240r. FIG. 2 represents the transmission, and cutoff of the red, blue and green wavelengths created by the color separation filters 124c and 124y of the prior art system 100 of FIG. 1. The blue light created by the color separation filters 124c and 124y has a cutoff point 280b. A blue light cutoff 280b in FIG. 2 is approximately 472 nanometers (or abbreviated as nm).

Green light cutoffs are determined at two locations on the graph, 270g and 260g. Green light cutoff 270g is located at approximately 518 nm and the green light cutoff 260g is located at approximately 560 nm. The red light cutoff 240r is located on the graph at approximately 615 nm.

FIG. 3 is a graph which compares the prior art FIG. 2 slopes 250 of light transmission versus wavelength with the slopes 350 of light transmission versus wavelength produced by the embodiment of FIG. 8 in accordance with the present invention. The slopes 350 show the available frequencies of light that can be transmitted from the lamp 810 to be combined and projected from the lens 880 in the direction of 882.

The present invention in the embodiment of FIG. 8 increases the bandwidth of the colors red, green and blue (shown by the dashed slopes 350 of FIG. 3) versus the FIG. 2 prior art bandwidth of the colors red, green and blue (shown on the FIG. 3 graph by the solid slopes 250). The prior art blue cutoff (approximately 472 nm) is shown at point 280b on solid line slope 250. The new blue cutoff is shown at a location on the dashed slope 350 identified by 382b (approximately 478 nm).

The prior art green light cutoffs are shown at a location **270g** (approximately 518 nm) and a location **260g** (approximately 560 nm) on the solid sloped line **250** in FIG. 3. The wider bandwidth of the embodiment of FIG. 8 is shown by locations **372g** (approximately 512 nm) and **362g** (approximately 566 nm) on the dashed sloped line **350** in FIG. 3.

The prior art red light cutoffs are shown at a location **240r** (approximately 615 nm) on the solid sloped line **250** in FIG. 3. The wider bandwidth of the present invention is shown by a location **342r** (approximately 609 nm) on the dashed sloped line **350** in FIG. 3.

Generally speaking the greater bandwidth of the FIG. 8 embodiment versus the FIG. 1 prior art embodiment means that if the same amount of light is supplied by lamp **110** and lamp **810**, the system **800** of FIG. 8 will produce more light at its output than the prior art system of FIG. 1.

FIG. 4A shows an aperture wheel **400** for use with the embodiment of FIG. 8 of the present invention for modifying the bandwidths of the red, blue or green light. The aperture wheel **400** is comprised of apertures **410**, **412**, **414**, **416**, **418**, **420**, and **422**, and motor **440**.

The arrows **402** show that the wheel **400** can be rotated to bring the apertures **412**, **414**, **416**, **418**, **420**, and **422** in a desired position. The apertures **412**, **414**, **416**, **418**, **420**, and **422** may be comprised of bandwidth modifying filters and if desired at least one of the apertures **412–422** may be left without a filter to pass light unobstructed. Any of the apertures **410–422** may also be aluminum or a suitable light blocking material to act as a shutter. The motor **440** is used to rotate the aperture wheel **400**. The aperture wheel **400** can be called an aperture device and can be used in the embodiment of FIG. 8 for any of the aperture devices in FIG. 8, such as aperture device **848r**.

FIG. 4B shows a side view of the aperture wheel **400** of FIG. 4A. Filters **412a** and **418a** are shown fixed over apertures **412** and **418**, respectively, in any suitable way. The motor **440** is shown connected to a motor shaft **445**. The motor shaft **445** is fixed to the aperture wheel **400** in any suitable way.

FIG. 5 is a graph which includes three different available slopes of light transmission versus wavelength for the colors of red, green and blue light frequencies. Referring to FIG. 5, the three different cutoffs of **280b**, **382b** and **586b** are all blue cutoffs. The point **382b** is obtained by using color separators **824c** and **824y** specially selected to combine to produce that slope cutoff point. In this case if we refer to FIG. 8, aperture devices **848r** and **844r** are most likely in a through hole position so that no additional modification of the blue light from the color separators **824c** and **824y** takes place. If next we energize a motor to move a color modifying filter into place we can alter the color of the blue light so that the frequency changes as shown by the slope **280b** of FIG. 5. In this example, we are just altering the blue light color and not the red or green. If we energize the motor on aperture device **848r** or **844r** to bring yet another different modifying filter into place, we further alter the frequency of light being sent to the blue light valve **850b** of FIG. 8 so that the slope on the graph changes to 50% point **586b** of FIG. 5. At no time did the rest of the slopes for Green and Red change as we were only changing the Blue aperture devices.

The 50% cutoff points for the blue, green, green, and red light on the solid slopes **350** of FIG. 3 are at points **382b**, **372g**, **362g**, and **342r**, respectively. The blue cutoff **382b** (approximately 478 nm) can be modified by an aperture wheel like aperture wheel **400** of FIG. 4A or aperture wheel

**600** of FIG. 6A in order to provide for selectable cutoffs. I.e. the aperture wheel **400** may be the aperture device **848b** and/or the aperture device **844b** in the FIG. 8 embodiment. The motor of the aperture device **440** of FIG. 4a may rotate the apertures on the aperture device to place a color modifying filter in the light path of the blue light reflected by the color separator **824y** of FIG. 8. The green light cutoffs **372g** and **362g** can be modified by an aperture wheel like aperture wheel **400** of FIG. 4A or aperture wheel **600** of FIG. 6A. The aperture wheel **400** or **600** may be the aperture device **848g** or **844g**. The aperture wheel **848g** or **844g** may be controlled to modify the cutoff of **372g** and **362g** to new selectable cutoffs of **270g** (approximately 512 nm) and **260g** (approximately 560 nm) on the slopes shown as dashed lines **250** or cutoffs of **576g** (approximately 525 nm) and **566g** (approximately 552 nm) on the dashed slopes **550**.

The red cutoff **342r** can be modified by an aperture wheel like aperture wheel **400** of FIG. 4A or aperture wheel **600** of FIG. 6A as to now provide for selectable cutoffs. The aperture wheel **400** or **600** may be the aperture device **848r** or **844r** in FIG. 8. The aperture wheel **848r** or **844r** may be controlled to modify the red light cutoff of **342r** (approximately 609 nm) to **240r** (approximately 615 nm) on the dashed slope **250** and **546r** (approximately 628 nm) on the dashed slopes **550** in FIG. 5.

FIG. 6A shows another type of aperture wheel **600**. The aperture wheel **600** has trapezoidal apertures **612**, **614**, **616**, **618**, **620**, and **622**. The apertures **612–622** may be color filter sections such as dichroic filters or other color filters known in the art. The apertures **612–622** may also be aluminum or a light blocking material to act as a shutter. The apertures **612–622** are fixed to the central section **644** of the aperture wheel **600** by any suitable means. A motor **640** rotates the apertures **612–622** to a position in the path of a light. Shutters and color filters may be positioned in any aperture location (of apertures **612–622**) on the aperture wheel **600**. The aperture wheel **600** may only use one or two apertures as desired and not all of the apertures **612–622** need to have filters or light blocking material and some can be left open if desired. Blocking in the present application may mean blocking by shutter a particular color light without changing the frequency.

FIG. 6B shows a side view of the aperture wheel **600**. A side view of the apertures **618**, **620**, and **622** are also shown. Each of the apertures **618**, **620**, and **622** may include a color filter or shutter. The motor **640** has a motor shaft **645** that is fixed in any suitable manner to the aperture wheel **600** to rotate the aperture wheel **600**. The aperture wheel **600** can rotate with respect to the motor **640**.

FIG. 7 shows a remote console **780**, a power source **790**, and a control system **760**. The control system **760** would be part of and used in a lighting device such as lighting device **1050** of FIG. 10. The power source **790** provides power to the lighting device, such as **1050** and the remote console **780** can control the lighting device **1050**.

The control system **760** in FIG. 7 includes thermal monitoring device **714**, sensor **716**, sensor **718**, a light valve driving device **720**, a motor drive device **722**, a lamp power supply **724**, a power supply **726**, microprocessor **728**, and communications node **730**.

The remote console **780** for generation of command signals receives power from the power source **790** (which may be a power line) and the power source **790** is coupled to the remote console **780** through conductors **796** in a known manner. A communications cable **772** is connected between the remote console **780** at connection point **770** and

the control system 760 at connection point 774. The communications used over the communication cable 772 may be serial data that contain unique addresses for discrete communication with potentially a plurality of multiple light valve lighting devices, such as for example, lighting device 1060 or 1050 shown in FIG. 10. The communications used over the communication cable 772 may be bi-directional or more than one communications system may be used for example that disclosed in my copending application titled "METHOD AND APPARATUS FOR DIGITAL COMMUNICATIONS WITH LIGHTING DEVICES" Ser. No. 09/394,300 filed Sep. 10, 1999, incorporated by reference herein.

Control system 760 of FIG. 7 may be enclosed within a housing of a lighting device like that shown as 1050 of FIG. 10. The communications node 730 of FIG. 7 receives command signals from the remote console 780 over the communications cable 772 through the connection point 774 and the conductors 734. The connection point 774 may be a suitable connector as known in the art and is connected by conductors 734 to the node 730. The communications node 730 transfers data and commands from the remote console 780 to microprocessor 728 through conductors 729.

The microprocessor 728 may also include the memory necessary for the operating system and the processing of commands. The microprocessor 728 may be comprised of several microprocessors or it may be constructed of several discrete logic circuits. Power supply 726 is connected through conductors 736 and power connection point 794 to the power source 790. The power source 790 provides the necessary power to the power supply 726 through connection point 794 and through internal conductors 736 and to the lamp power supply 724 through conductors 725. The power supply 726 is connected to the microprocessor 728 through conductors 727 and to the lamp power supply 724 through conductors 725. The lamp power supply 724 is connected to the lamp 810 through conductors 711. The lamp power supply 724 may also receive control signals through the conductor 732 from the microprocessor 728.

The microprocessor 728 receives thermal information from the thermal monitoring device 714 via conductors 719. The thermal monitoring device 714 may receive information from multiple thermal sensors such as the sensors 718 and 716 through conductors 717 and 715, respectively. The sensors 718 and 716 can be any thermal sensor as known in the art.

The microprocessor 728 connects to the motor drive device 722 through conductors 723 and may provide power and control signals to the motors 846r, 840r, 846g, 840g, 846b, and 840b. The motor drive device 722 connects to the motors 846r, 840r, 846g, 840g, 846b and 840b through conductors 747r, 741r, 747g, 741g, 747b and 741b, respectively. The motors 846r, 840r, 846g, 840g, 846b and 840b rotate aperture wheels 848r, 844r, 848g, 844g, 848b and 844b, respectively. The microprocessor 728 is connected to the light valve driving device 720 through conductors 721. The light valve driving device 720 controls the light valves 850r, 850g and 850b over conductors 752r, 752g, and 752b. The conductors 736, 734, 729, 727, 723, 725, 711, 721, 752r, 752g, 752b, 747r, 741r, 747g, 741g, 747b, 741b, 732, 717, 715, and 719 are shown simplified. The conductors may be multiple conductors and may be wired or copper conductors such as for example a circuit board as known in the art.

FIG. 8 shows an optical apparatus 800 of an embodiment of the present invention of the invention using three light valves 850g, 850b, and 850r. The apparatus 800 also

includes a lamp 810, polarization converter 818, reflectors 812, 830a, 830d, 830e, color separators 824c and 824y, motors 840r and 846r and aperture wheels 844r and 848r, motors 840b and 846b and aperture wheels 844b and 848b, motors 840g and 846g, and aperture wheels 844g and 848g, a color combining device 876, and a focusing lens 880.

The lamp 810 has its energy focused by the reflector 812. The lamp produces visible white light with light components having red, blue and green wavelengths. The white light focused by the reflector 812 as shown by an arrow 814 is directed to the polarization converter 818. The white light exits the polarization converter 818. The purpose of a polarization converter is known in the art. It converts the unpolarized white light from the lamp 810 and reflector 812 into polarized light. The light valves 850g, 850b, and 850r operate with polarized light. In one controlled condition the light valves 850g, 850b, and 850r let polarized light pass through and in the other controlled condition light is blocked from passing. Color separator 824c can be a dichroic color separation filter that reflects or separates out red light in the direction of an arrow 828 while transmitting or separating out a residual light comprised of blue and green light in the direction of an arrow 860. The color red light which is reflected at the first color separator 824c can be called the first color light in a process in accordance with an embodiment of the present invention.

The red light as shown by arrow 828 is directed towards the two aperture wheels 848r (driven by the motor 846r) and 844r (driven by the motor 840r). The aperture wheels 848r and 844r may be similar to aperture wheels shown in FIGS. 4A-B and 6A-B and may be considered aperture devices by themselves or in combination or in combination with the motors 840r and 848r. The red light may pass through the selected filters or shutters positioned by the aperture wheels 848r and 844r in the path of the red light at the location shown by arrow 828 and may next travel in the direction of an arrow 832 to the reflector 830e. The red color light next travels in the direction of an arrow 834 towards a variable aperture 892r. The variable aperture 892r may be an iris. The term iris, generally speaking, is known in the art. The variable aperture 892r may be motorized. The variable aperture 892r may act as a mask to change a rectangular image created by a rectangular light valve, which is the type of light valve that light valve 850r may be, to a round image that is adjustable. The red light passes through the variable aperture 892r, then through the light valve 850r where the red light is controlled through the light valve 850b in a manner known in the art. The red light may pass through the light valve 850b to the color combining device 876.

The residual blue and green light transmitted or separated out by color separator 824c is directed towards the color separator 824y as shown by arrow 860. Color separator 824y reflects blue light, which is directed towards the two aperture wheels 848b (driven by the motor 846b) and the aperture wheel 844b (driven by the motor 840b). The aperture wheels 848b and 844b may be similar to those shown in FIGS. 4A-B or 6A-B and may be thought of separately or in combination or in combination with the motors 840b and 846b as aperture devices. The blue light may pass through a selected filter or shutters (similar to that shown in FIGS. 4A-B or 6A-B) positioned by the aperture wheels 848b and 844b in the path of the blue light at the location of arrow 862 and may next travel in the direction of arrow 864 towards a variable aperture 892b. The variable aperture 892b may be an iris. The variable aperture 892b may be motorized. The variable aperture 892b may act as a mask to change a rectangular image created by a rectangular light valve,

which is the type of light valve that light valve **850b** may be, to a round image that is adjustable. The blue light passes through the variable aperture **892b**, then through the light valve **850b** where the blue light is controlled through the light valve **850b** in a manner known in the art. The blue light may pass through the light valve **850b** to the color combining device **876**.

Color separator **124y** transmits or separates out green light towards reflector **830a** as shown by an arrow **870**. Reflector **830a** reflects the green light towards the two aperture wheels **848g** (driven by the motor **846g**) and the aperture wheel **844g** (driven by the motor **840g**). Aperture wheels **848g** and **844g** may be similar to those shown in FIGS. 4A–B or FIGS. 6A–B and may be considered to be separately or in combination, or in combination with motors **846g** and **840g** to be aperture devices. The blue light may pass through a selected filter or shutter positioned by the aperture wheels **848g** or **844g** in the light path and may next travel in the direction towards the reflector **830d**.

The green light is reflected off of reflector **830d** in the direction of the arrow **874** towards a variable aperture **892g**. The variable aperture **892g** may each be an iris. The variable aperture **892g** may be motorized. The variable aperture **892g** may act as a mask to change a rectangular image created by a rectangular light valve, which is the type of light valve that light valve **850g** may be, to a round image that is adjustable. The green light passes through the variable aperture **892g**, then through the light valve **850g** where the green light is controlled through the light valve **850g** in a manner known in the art. The green light may pass through the light valve **850g** to the color combining device **876**.

The color combining device **876** combines the red, green and blue light controlled by the light valves **850g**, **850b**, and **850r** and the combined light is sent in the direction of the arrow **878** towards a prism **890** which may be a Dove prism as known in the art for rotation of images created by the light valves **850g**, **850b**, and **850r**. The prism **890** may be rotated with a motor as known in the art. The green light may pass through the prism **890** and then to the focusing lens **880**. An image is focused in the direction of arrow **882** onto a projection surface not shown.

FIG. 9A shows an apparatus **900** comprised of a shutter device, single color filter, or light blocking material **902**, a motor shaft **904**, and a motor **906**. The single color filter **902** can be rotated into a light path by the motor **906**. The filter **902** rotates with respect to the motor **906** on the shaft **904**. The shaft **904** is rotatably connected to the motor **906**, and the shaft **904** is fixed to the filter or light blocking material (shutter) **902** in any suitable way. Arrows **912** show the direction of the filter or light blocking material **902** when the motor **906** is energized and the shaft **904** is rotated. Apparatus **900** can be considered an aperture device in accordance with the present invention and can be placed in the FIG. 8 embodiment in the same locations as any of the aperture devices for example **844r** or **846r** of FIG. 8. Or **846r** could be an aperture device that is an aperture wheel while **844r** could be apparatus **900** of FIG. 9 and might act as a shutter only as **902** is fitted with light blocking material.

FIG. 9B shows a linear aperture device **950** that can insert apertures into a light path. The linear aperture device **950** is comprised of apertures **930** and **932**, a mounting plate **938**, a power nut **940**, a worm gear shaft **942**, and a motor **944**. The apertures **930** and **932** may contain color filters or light blocking materials. The apertures **930** and **932** are fixed to the mounting plate **938** that is in turn fixed to the power nut **940**. The power nut **940** is driven by a worm gear shaft **942**

by the motor **944**. The worm gear shaft **942** is rotatably connected to the motor **944**. Arrows **946** show the direction of movement of the apertures **930** and **932** when the motor worm gear shaft **942** is rotated. The device **950** of FIG. 9B can be used in any location where an aperture device is used. For example it could be placed in the location of **844r** of FIG. 8. It could place a color filter or a light blocking material into the path of the red light before the light passes through to the reflector **830e**.

Video projection systems used for projecting conventional video in the prior art have a preferred color range for video. For example in the prior art devices, such as FIG. 1, the color separators **124c** and **124y** work together as known in the art to separate white light emitted from a lamp into separate red, green and blue components. Specifications of the color separators **124c** and **124y** are designed so that the bandwidths of red, green and blue light are controlled to produce the best video image. This is important to video because if the colors of red, blue and green light have too wide a bandwidth, the video images can appear washed out and unnatural looking to the viewer. If the bandwidths of red, green, and blue light are too narrow the color will look very saturated but the projector can suffer from poor overall output. An example of the prior art bandwidths and cutoff frequencies for video is shown in FIG. 2.

The present invention in various embodiments specifies a color separation system with wide bandwidths and a selectable bandwidth system for modifying the color palette of a multiple light valve lighting device for lighting applications. FIG. 3 shows the prior art cutoffs for red, green and blue light on the solid slope line **250** on the transmission graph. The dashed line **350** shows an increased bandwidth of the present invention over the prior art for red, green and blue light. It is preferred to have the greatest bandwidth possible for each of the red, green and blue colored lights. Once the wide bandwidth color separation system of the present invention is used, selectable aperture wheels or aperture devices with variable cutoff frequencies can be placed in the locations of for example aperture wheels **848g**, **844g**, **848b**, **844b**, **848r** and **844r** of FIG. 8 to provide adjustable bandwidths for the red, green and blue wavelengths.

FIG. 5 illustrates a wide bandwidth color separation system of the present invention of red, green and blue light as shown by the solid slopes **350**. Selectable aperture wheels, such as apertures wheels **400** and **600** of FIGS. 4A–B and FIGS. 6A–B, respectively, can be used as such as one or more of aperture wheels **848r** and **844r** (to modify the red light) as one or more of aperture wheels **848b** and **844b** (to modify the blue light) and as one or more of aperture wheels **848g** and **844g** (to modify the green light). As in FIG. 8, the aperture wheels **848r** and **844r**, **848b** and **844b**, **848g** and **844g** can be used before the light valves (such as **850r**, **850b**, and **850g** in FIG. 8, respectively) and after the one or more color separators (such as **824c** and **824y**). In the preferred version of the present invention, the selectable aperture wheels or aperture devices are located before the light valves (such as aperture wheels **848r** and **844r** before light valve **850r**) but it is possible to locate the selectable aperture wheels after the light valves.

The solid slopes **350** in FIG. 5 shows the FIG. 8 embodiment with the aperture devices **848r**, **848g**, **848b**, and **844r**, **844g**, and **844b** in an unmodified case, i.e. all of the aperture devices act as through holes with no filter. In FIG. 5 the unmodified color separation cutoff point of the blue light is shown as **382b** on the solid slopes **350** and has a cutoff of approximately 478 nm. In the “unmodified case” the aperture wheel **444** like that shown in FIG. 4A or aperture wheel

## 11

600 of FIG. 6A has an aperture (such as one of apertures 410–422 or apertures 612–622) selected into the blue light path that is a through hole with no filter. In this way the blue light reflected from color separator 824y of FIG. 8 passes freely through the selected apertures of the aperture wheels 848b and 844b without modifying the cutoff of the blue light. The green light and the red light are treated similarly to the blue light in the unmodified case.

The dashed slopes 250 shows a case where one of the aperture wheels for each colored light path has been rotated so that an aperture with the appropriate cutoff filter has been placed into the appropriate light path. For example, 280b shows a modified cutoff over 382b. The 280b cutoff is approximately 472 nm and it is now apparent that the bandwidth has been reduced. The 280b cutoff was produced when one of the aperture wheels 848b or 844b of FIG. 8 was rotated so that an aperture with the appropriate cutoff filter was placed into the blue light path.

The term cutoff filter, as used in this application, is a filter designed to cutoff unwanted frequencies and to produce a desired frequency range. An aperture device or component of an aperture device comprised of a group of cutoff filter would allow for the selection of different cutoff frequencies. The selection of different frequencies would appear visually as modifications of the original colors of light. When a frequency is modified from an original frequency different cutoff filters representing different cutoff frequencies are selected to be placed in the path of light after a color separator.

The dashed slopes 550 shows a case where one of the aperture wheels for each colored light path has been rotated so that an aperture with a different cutoff filter has been placed into the appropriate light path. For example, by rotating one of the aperture wheels 848b or 844b to a new aperture, a different cutoff filter can be placed into the blue light path producing a result like that of 586b of FIG. 5. When the aperture wheel, such as wheel 848b is rotated to place a cutoff filter that produces the results of 586b of FIG. 5 into place, it is clear that the bandwidth of the blue light has been substantially narrowed over that of the unmodified bandwidth having a cutoff point at 382b. The cutoff point of 586b is approximately 460 nm.

It could be possible to just simply electronically switch off (preventing the light to pass through the light valve) all of the areas around a round transmitted image created by the light valves 850g, 850b, and 850r in FIG. 8, by the light valves themselves. However it can be possible to see a ghost image of the areas surrounding the round image created by the light valves 850g, 850b, and 850r because each of the light valves may not be capable of switching off one hundred percent (100%) of the light surrounding the round image. With a variable aperture, (such as variable apertures 892r, 892g, and 892b) the areas around the desired round image can be masked.

The irises or variable apertures 892r, 892g, and 892b for the corresponding individual light valves 850r, 850g, and 850b, respectively, may be driven by motors as known in the art and may respond individually or all together. The size of the aperture created by each of the variable apertures 892r, 892g, and 892b can be controlled by commands sent from the remote console 780 in FIG. 7 if desired.

It is also possible to have aperture wheels that contain different types of apertures located in the variable aperture position of 892r, 892b and 892b. Aperture wheels that contain different types of apertures are known in the art as gobo wheels. They are also driven by motors. The gobo

## 12

wheels containing two or more apertures each, may respond individually to modify the aperture size prior to the corresponding appropriate light valve, such as 850r, 850g, or 850b or gobo wheels may respond all together to modify the aperture prior to all the light valves 850r, 850g, or 850b.

Variable apertures, such as variable apertures 892g, 892b, and 892r can be used as in FIG. 8 before corresponding light valves 850g, 850b, and 850r, respectively. In either case the light valves 850g, 850b, and 850r can be a reflective or a transmissive type. Variable apertures, such as variable apertures 892g, 892b, and 892r can also be used after corresponding light valves 850g, 850b, and 850r, respectively, but before the color combining device 876. In either case the variable apertures 892g, 892b, and 892r should also be used after white light has been separated into the component colors of light, which in this case is green, blue, and red light.

While only two bandwidth modification examples are shown in FIG. 5 for the modification from the unmodified slope 350 of FIG. 5, it is clear that many more incremental modifications can take place for each of the blue, green and red lights. An aperture wheel, such as aperture wheel 848b, 848g, 848r, 844b, 844g, or 844r or aperture device may contain many more filters for further modifying the bandwidth.

In FIG. 5, the green light spectrum from the color separation system of an embodiment of the present invention is shown on the solid sloped line 350 which includes the green cutoff points 372g and 362g. The solid sloped line 350 is again the unmodified case for FIG. 8, i.e. a through hole for all of the aperture devices or aperture wheels. The aperture wheels 848g and 844g for green light are positioned in front of the green light valve 850g in FIG. 8 similar to the way the aperture wheels 848b and 844b are positioned for the blue light valve 850b discussed above. The green light transmitted through color separator 824y of FIG. 8 reflects off of reflector 830a and passes through the aperture wheels 848g and 844g. The aperture wheels 848g and 844g may be similar to aperture wheel 400 of FIG. 4A or aperture wheel 600 of FIG. 6A.

If one of the aperture wheels of 848g and 844g is rotated to position a cutoff filter into the green light path at the location of arrow 872 in FIG. 8, a modification to the green light color cutoff can take place. For example, cutoff points 270g and 260g are shown on dashed slopes 250 of FIG. 5 and together show a narrower band of green light than cutoff points 372g and 362g for the unmodified case. The result of narrowing the green bandwidth to the bandwidth between the cutoff points of 270g and 260g was accomplished by rotating a cutoff filter into the green light path at location of arrow 872 in FIG. 8 by one of the aperture wheels 848g or 844g of FIG. 8. If yet a different cutoff filter were to be placed into the green light path by one of the aperture wheels 848g or 844g of FIG. 8 then we can see the results on the dashed slopes 550 on which the cutoff points 576g and 566g are located in FIG. 5. The cutoff points of 576g and 566g of FIG. 5 have produced a substantially narrower bandwidth and in turn a more saturated green color than the original unmodified bandwidths on the solid slope 350 corresponding to the cutoff points of 372g and 362g.

It is important to note that it is possible to use combinations of cutoff filters to modify the color of light produced by the color separation system of the present invention. For example, in FIG. 5 we could select a cutoff filter to be placed on the aperture wheels (such as one of aperture wheels 848g or 844g) that only modifies one side of the green bandpass.

In this example we might only modify the original cutoff point **372g** to a cutoff point of that shown by **576g** yet there will be no modification to the cutoff point of **362g** of the green light. Combinations of high pass cutoff and low pass cutoff filters can allow for many variations in the green color bandwidth.

Cutoff point **342r** of FIG. 5 shows an unmodified color separation cutoff for the red light on the unmodified solid slopes **350**. In the unmodified state the aperture wheels **848r** and **844r** of FIG. 8 have been rotated to an unfiltered aperture for the cutoff point of **342r**. A modification to the cutoff point of **240r** of dashed line slopes **250**, is produced when an aperture containing a cutoff filter is rotated into position by one of the aperture wheels **848r** or **844r** of FIG. 8. For example, the cutoff point of **240r** on the dashed slopes **250** produces a narrower bandwidth red than the cutoff point of **342r**. Additional cutoff filters can be rotated into place by the aperture wheels **848r** or **844r** of FIG. 8 to produce a cutoff point like **546r** of FIG. 5 on the dashed slopes **550**.

Lighting devices are often used on a stage where total darkness is possible. It is desirable to have high contrast ratios on the projection surface (such as surface on which the combined light is projected towards in the direction shown by arrow **882** in FIG. 8) between the image to be projected and the part of the projection surface that is supposed to be absent of any light. For instance, a multiple light valve lighting device might normally produce a rectangular image. This is because many of the available light valves have a rectangular aperture as known in the art. It could be a requirement for the lighting device to project a round image. While projecting the round image it is most desirable to effectively black out the outside corners of the rectangular image surrounding the round image. Unfortunately, light valves are not 100% effective in blocking out all the light when in the light blocking state. This means that an audience might still see a ghost of the original rectangular image when the lighting device is projecting the round image. In order to improve this situation under certain conditions, the invention uses apertures with light blocking material (or shutters) on the aperture wheels to block the light before it passes through the light valve. For example, if a round image were comprised entirely of blue and red light and as there is no need for the green light, a shutter would be placed into the path of the green light before the green light passes through the green light valve. In the embodiment of the present invention of FIG. 8, aperture wheel **848g** or **844g** may contain at least one shutter aperture for blocking the path of light. In the prior art when projecting images were comprised of red and blue light only, some small amount of green light would leak through the green light valve and further reduce the contrast ratio. With the embodiment of the present invention of FIG. 8, when an image is projected and is comprised entirely of red and blue light, an aperture containing a shutter would be placed, (such as on aperture wheel **848g** or **844g**) to block the green light from passing through the aperture wheel (such as aperture wheel **848g** or **844g**) to the green light valve (such as valve **850g**).

Similarly, when an image is projected entirely of green and blue light an aperture containing a shutter would be placed (such as on aperture wheel **848r** or **844r**) to block the red light from passing through the aperture wheel to the red light valve (such as **850r**). Also similarly when an image is projected entirely of green and red light an aperture containing a shutter would be placed (such as on aperture wheel **848b** and **844b**) to block the blue light from passing through the aperture wheel to the blue light valve (such as valve **850b**). Depending on what the image is comprised of, more

than one aperture devices may block the light to more than one light valves. For instance, if the image is comprised of only blue light then it is possible to block the light to the red and green light valves.

When the lighting device, such as lighting device **1050** of FIG. 10 of the present invention, is not being used to project an image, such as via light shown by dashed lines **1055** and **1054**, the aperture wheels (**848r** and **844r**, **848g** and **844g**, **848b** and **844b**) for the red, green and blue light can rotate to place shutters to block the red, green and blue light from passing through to their prospective light valves (such as **850r**, **850g**, and **850b**). In this way the invention prevents any light leakage from passing through the red, green and blue light valves insuring a good black out in very dark conditions.

FIG. 4A shows an aperture wheel **400** with round apertures **410-422**. The apertures **410-422** would be sized to allow the desired amount of light to pass through each aperture and then to the appropriate light valve. The apertures **410-422** on the aperture wheel **400** of FIG. 4A could also be of different shapes including rectangular or square. Any of the apertures **410-422** may have cutoff filters or color modifying filters, contain no filter and be a through hole, or may contain a shutter.

FIG. 6A shows an aperture wheel **600** with wedge shaped apertures **612-622**. The apertures **612-622** would be sized to allow the light passing through the appropriate aperture on it's way to the appropriate light valve so that all the desired light would pass through the light valve. Any of the apertures **612-622** may have cutoff filters or color modifying filters, contain no filter and be a through hole, or may contain a shutter.

It is possible that the aperture wheels **848r**, **848b** and **848g** may only be used as shutters and contain no cutoff filters. In this case only a single shutter aperture may be needed. This could improve the speed of the shutter allowing faster transitions between passing and blocking the light to the appropriate light valve (such as one of light valves **850g**, **850b**, and **850r**). FIG. 9A shows single aperture device **900** that could either contain a filter or a shutter.

Various aperture devices can be used to place apertures into and out of a light path instead of an aperture wheel. FIG. 9B shows an aperture slide device **950** where apertures **930** and **932** are moved linearly into and out of the light path. Either aperture **930** or aperture **932** can contain filters of light blocking material. The aperture slide device **950** can be used instead of or combined with one or more of the aperture wheels **848r**, **848g**, **848b**, **844r**, **844g**, or **844b**, and at any of the locations of those aperture wheels in the FIG. 8 embodiment.

Instead of a mechanical aperture device that places filters into a light path, an aperture device like an electronically switchable spectral filter like that produced by ColorLink of Boulder Colo. ([www.colorlink.com](http://www.colorlink.com)) could be used for modification of the color produced by the color separation system. By chromatically manipulating polarization, the switchable spectral filter can be designed to provide several different cutoff frequencies used to modify the color spectrum sent by a color separator to a light valve (such as light valves **850g**, **850r**, and **850b** of FIG. 8).

FIG. 11 shows the apparatus **1100** which is basically the same as the apparatus **800** of the embodiment of FIG. 8, except that electronically switchable spectral filters have been substituted for aperture wheels (and their motors). Electronically switchable filters **111r** and **111b** have been substituted for aperture wheels **848r** and **844r** (and their

motors), electronically switchable filters **1110b** and **1115b** have been substituted for aperture wheels **848b** and **844b** (and their motors), and electronically switchable filters **1110g** and **1115g** have been substituted for aperture wheels **848g** and **844g** (and their motors).

FIG. 7 shows a control system **760** for controlling aperture wheels **848r**, **844r**, **848g**, **844g**, **848b**, and **844b** and lighting valves **850r**, **850g**, and **850b** of the FIG. 8 embodiment. The control system **760** and the remote control **780** is used for the operation of a multiple light valve lighting device such as device **1050** of FIG. 10.

In operation, signals are sent over a communications system from the remote console **780** to the control system **760** through the wiring conductors **772**. The communication system may be used to send program material to the control system **760** from the remote console **780**. The program material may provide information as to how the light valves **850r**, **850g**, and **850b** are controlled to produce an image. Some examples of program material are computer graphic and video signals. It is also possible that a second communication system between the remote console **780** and the control system **760** may be used to send live video or graphical information to be stored into memory of the microprocessor **728** of FIG. 7.

The control system **760** has a communications node **730** for receiving communication signals from the remote console **780**. The communications node **730** passes the signals to the microprocessor **728** through the conductors **729**. The microprocessor **728** receives the data as received by the communication node **730** and first determines if the unique address data contained from the received data is the correct address as known in the art. If the microprocessor **728** determines that it has received a correct address contained within the received data, the microprocessor **728** may next act upon a command signal contained within the received data that is sent from the remote console **780** over the communications system. If a command signal is sent from the remote console **780** that contains a command for modification of the green color, the microprocessor **728** sends control signals via conductors **723** to the motor drive device **722** that in turn sends the appropriate control signals to the motors **840g** or **846g**.

The microprocessor **728** may also receive commands from the remote console **780** to control the light valves **850r**, **850g**, and **850b**. The microprocessor **728** sends control signals via the conductors **721** to the light valve controlling device **720**. The light valve controlling device **720** determines which one of the light valves of light valves **850r**, **850g**, and **850b**, the microprocessor **728** desires to control, and sends the appropriate control signals to the light valves **850r**, **850g** or **850b** though conductors **752r**, **752g**, or **752b**, respectively.

The microprocessor **728** receives its necessary operating power from the power supply **726** through conductors **727** and also routes power through conductors **729**, **721**, **719** and **723** to the communications node **730**, the light valve controlling device **720**, thermal monitoring device **714**, and the motor drive device **722**. The power supply **726** also supplies power to the lamp power supply **724** via conductors **725**. The lamp power supply **724** may receive control signals from the microprocessor **728** through conductors **732**. The lamp power supply **724** supplies the necessary power to operate the lamp **810**. The lamp power supply **724** may be variable so as to supply variable power to the lamp **810**.

The lamp power supply **724** may be capable of supplying power to the lamp **810** in excess of the manufacturer's

continuous rated power level, for example if the lamp **810** is rated by the manufacturer at 200 watts the power supply **724** may deliver upon signals 300 (three hundred) watts or greater to the lamp **810**. It is possible to control the amount of power to the lamp **810** in accordance with the amount of light energy to pass through a particular light valve (such as one of light valves **850r**, **850g**, or **850b**). For example more saturated colors have less energy to pass through a light valve while less saturated colors pass more energy through the light valves. If one or more of the light valves, such as light valves **850r**, **850g**, and **850b** has a limit as to how much energy can be transmitted through the light valve the power to the lamp **810** may need to be regulated to reduce the energy. If one or more of the light valves **850r**, **850g**, or **850b** has a limit as to how much energy can be blocked by that light valve, the power to the lamp **810** may have to be regulated to reduce the energy. It can be possible using duty cycle control to increase the power to the lamp **810** for brief durations so that light energy passing through the light valves **850r**, **850g**, and **850b** is of higher energy than normally would be allowed as a continuous duty. By varying the power to the lamp **810** under different conditions, the lighting device **1050** of FIG. 10 can be optimized for maximum light output under a variety of conditions. In FIG. 7, the control system **760** may automatically adjust the power to the lamp **810** by determining the color spectrum in use, the placement of an aperture device, such as an aperture on one of aperture wheels **848r**, **844r**, **848g**, **844g**, **848b**, or **844b** into the light path, the control condition of a light valve (such as one of light valves **850r**, **850g**, or **850b**), or even the physical placement of the lighting device **1050** of FIG. 10.

It is also possible for the lighting device **1050** of FIG. 10, to automatically close and open light blocking apertures (shutters), such as on aperture wheel **848r**, based upon the state of the light valves (such as light valve **850r**) as controlled by the light valve controlling device **720** as determined by the microprocessor **728** of FIG. 7. For example, when the green light valve **850g** of FIG. 7 of an embodiment of the present invention is controlled to the light blocking state for any given amount of time the green aperture device **844g** can block the light path of the green light from reaching the green light valve **850g**. The microprocessor **728** of FIG. 7 monitors the state of the red, green and blue light valves **850r**, **850g**, and **850b**, respectively, as controlled by the light valve controlling system **720** and if any of the light valves are determined to be in the light blocking state for any given period of time, the microprocessor **720** will next send control signals to the motor drive device **722** of FIG. 7 to operate one of the motors **846r**, **840r**, **846g**, **840g**, **846b** or **840b** of the respective light valves to rotate the motor and change the aperture of the aperture device such as one of aperture wheels **848r**, **844r**, **848g**, **840g**, **848b** or **844b**. The light blocking state is defined as when a light valve of light valves **850r**, **850g**, and **850b** are controlled by the light valve controlling device **720** to substantially block the light from passing through the light valve onward to the projection lens.

If the microprocessor **728** determines that all three light valves **850r**, **850g**, and **850b** are in the light blocking state, all of the aperture devices, such as aperture devices **848r**, **844r**, **848g**, **844g**, **848b**, and **844b** may block the light going to their respective light valves. This may be done automatically by monitoring the status of the light valve control signals. Also a black out command may be sent to the lighting device (like that shown as **1050** of FIG. 10) from the remote console **780** that is received by the communications node **730** and in turn is sent through conductors **729** to the

microprocessor **728**. The command is interpreted by the microprocessor **728** and control signals are sent to the motor drive device **722** to in turn operate the motors **846r**, **840r**, **846g**, **840g**, **846b**, and **840b**. The motors **846r**, **840r**, **846g**, **840g**, **846b**, and **840b** are operated to place a light blocking aperture from the aperture wheels **848r**, **844r**, **848g**, **844g**, **848b**, **844b** in front of light before their respective light valves. When the light blocking apertures of the aperture devices are placed to block the light with a light blocking material in the light path from the color separators, the aperture devices are considered to be in the light blocking state. Aperture wheels **848r** and **844r** (with or without their motors **846r** and **840r**) can be considered to be first and second components of a single aperture device. Similarly aperture wheels **848g** and **844g** can be considered to be first and second components of a single aperture device. Similarly aperture wheels **848b** and **844b** can be considered to be first and second components of a single aperture device.

It is also possible to reduce power to the lamp when the microprocessor **728** of FIG. 7 determines that all three light valves **850r**, **850g**, and **850b** are in the light blocking state. After the microprocessor **728** determines this the microprocessor may next send control signals over the conductors **732** to control the lamp power supply **724** to reduce the power to the lamp **810**. By reducing power to the lamp **810** the light output is reduced. When the light output is reduced by reducing power to the lamp **810** any light that is passing through the light valves **850g**, **850b**, and **850r** in the light blocking state is reduced and thus improves the contrast ratio. If any of the three light valves **850g**, **850b**, or **850r** is determined by the processor **728** not to be in the light blocking state a control signal is sent over the conductors **732** to control the lamp **810** power supply **724** to raise the power to the lamp **810** for normal operation.

FIG. 10 shows two similar multiple light valve lighting devices **1050** and **1060** connected over a communication system to a remote console **780**. The focussing lens **880** of the FIG. 8 embodiment is shown for projecting an image onto a stage **1020**. The stage could consist of various projection materials including screens, drapes, walls and flooring as well as props and other materials known in the art of stage lighting. The components of the FIG. 8 embodiment are located in the lighting device **1050**. The control system **760** of FIG. 7 is also located in the lighting device **1050**.

The combined light path from the lens **880** to a stage or projection surface **1020a** is shown as dashed lines **1054** and **1055**. Device **1060** is similar and may be identical to device **1050** and contains projection lens **1062**. A combined light path from the lens **1062** to the stage or projection surface **1020a** is shown by dashed lines **1064** and **1065**.

A remote console **780** sends commands over a communication system as known in the art over the communication cables **772** and **778**. Connectors **774**, **1076** and **1084** connect the communication cables into internal communication nodes (not shown) like **730** of FIG. 7. Connector **770** connects the communication cable **772** to the remote console **780**. A power source **790** such as that provided by the power line is connected to power the console **780** at **796** and device **1050** at **794** and device **1060** at **1095**.

The lighting device like that shown as **1050** of FIG. 10 should have a unique address so that it can respond to the command signals from the remote console **780** separately from other lighting devices such as **1060** of FIG. 10 on the same communications system as known in the prior art. In FIG. 10, two lighting devices are shown however many more may be connected to the same communications sys-

tem. Some examples of command signals sent over the communication system from the remote console **780** to the multiple light valve lighting device **1050** like that shown in FIG. 10 are: lamp on, lamp off, black out, color modify red, color modify green, color modify blue, shutter open red, shutter close red, shutter open green, shutter close green and shutter open blue, shutter close blue, all shutters open, and all shutters closed.

The operator of the remote console **780** may command the lighting devices **1050** or **1060** by using command signals over the communication system to vary the color palette. This may be done at any time that the lighting devices **1050** or **1060** are in operation and can be used to create special effects and vary the visual look of the projected colors for aesthetic reasons. The operator inputs to the remote console **780** the desired change to the color palette of a particular multiple light valve lighting device via a keypad or a switch entry system as known in the art. The remote console **780** processes the commands received by a keypad **782** and transmits command signals over the communication system over cable conductors **772** and **1078**. The command signals may also contain the unique address of the lighting device **1050** or **1060** that the operator wishes to command. A multiple light valve lighting device such a device **1050** of FIG. 10 receives the commands signals over the communications system and next determines if the lighting device **1050** or **1060** has the correct unique address to respond to the command signals. If the unique address received matches the unique address of the lighting device **1050** of FIG. 10, the lighting device **1050** next responds to the command signal by changing the color palette of the red, green or blue in accordance with the command issued by the operator through the remote console.

There are several different types of light valves known in the art. There are digital mirror devices (DMD) made by Texas instruments and the Liquid Crystal Displays (LCD) made by various manufacturers. The DMD is a reflective type light valve. LCD light valves may be of the reflective or transmissive type. FIG. 8 shows the transmissive type of light valves. Systems built similarly to prior art FIG. 1 are also built with reflective light valves. Regardless of the use of a reflective or transmissive light valves the aperture devices can be placed before or after the light valves and after the color separator system to modify the color before or after the light valves.

Although the invention has been described by reference to particular illustrative embodiments thereof, many changes and modifications of the invention may become apparent to those skilled in the art without departing from the spirit and scope of the invention. It is therefore intended to include within this patent all such changes and modifications as may reasonably and properly be included within the scope of the present invention's contribution to the art.

What is claimed is:

1. A stage lighting apparatus comprising:

- a lamp;
- a plurality of light valves;
- and wherein the lamp and the plurality of light valves cooperate to project an image comprised of a plurality of colors onto a stage;
- further comprising a control system;
- a communications node for receiving one or more unique address signals, one or more command signals and one or more program signals;
- wherein each of the one or more unique address signals is compared by the control system to a first unique

19

address to allow response by the control system to command signals;  
 wherein a first command signal of the one or more command signals received by the communications node varies the visual look of the plurality of colors; 5  
 and wherein the one or more program signals received by the communications node contain information as to how the plurality of light valves are controlled to produce the image.  
 2. The stage lighting apparatus of claim 1 further comprising 10  
 a variable aperture; and  
 wherein the variable aperture is varied by the control system by a second command signal of the one or more command signals. 15  
 3. The stage lighting apparatus of claim 2 wherein the variable aperture is an iris.  
 4. The stage lighting apparatus of claim 1 further comprising 20  
 an aperture device; and  
 wherein the aperture device is operated by the control system by a second command signal of the one or more command signals.  
 5. The stage lighting apparatus of claim 4 wherein the aperture device is a shutter. 25  
 6. The stage lighting apparatus of claim 4 wherein the aperture device is comprised of a color filter.  
 7. The stage lighting apparatus of claim 1 wherein each of the one or more program signals is comprised of 30  
 video information.

20

8. The stage lighting apparatus of claim 1 wherein each of the one or more program signals are comprised of computer graphic information.  
 9. A stage lighting apparatus comprising:  
 a lamp; and  
 a lens;  
 wherein the lamp and the lens cooperate to project an image comprised of a plurality of colors onto a stage; and further comprising a control system; and a variable lamp power supply;  
 wherein the control system can automatically control the variable lamp power supply to vary power to the lamp based upon a saturation of the plurality of colors; and wherein varying power to the lamp does not substantially vary the saturation of the plurality of colors.  
 10. A stage lighting apparatus comprising:  
 a lamp; and  
 a lens;  
 wherein the lamp and the lens cooperate to project an image comprised of a plurality of colors onto a stage; and further comprising a control system; and a variable lamp power supply;  
 and wherein the control system automatically controls the variable lamp power supply to vary power to the lamp based upon a spectrum of the plurality of colors; and wherein varying power to the lamp does not substantially vary the saturation of the plurality of colors.

\* \* \* \* \*