



US005633061A

United States Patent [19]

[11] Patent Number: **5,633,061**

Hewlett

[45] Date of Patent: **May 27, 1997**

[54] **MEDIUM FOR A COLOR CHANGER**

4,996,113 2/1991 Hector et al. 428/600

[75] Inventor: **William E. Hewlett**, Pasadena, Calif.

5,042,383 8/1991 Wirz 101/420

5,099,759 3/1992 Sonobe et al. 101/348

[73] Assignee: **Light & Sound Design, Ltd.**, United Kingdom

Primary Examiner—Donald Loney

Attorney, Agent, or Firm—Fish & Richardson P.C.

[21] Appl. No.: **286,969**

[57] **ABSTRACT**

[22] Filed: **Aug. 8, 1994**

[51] **Int. Cl.**⁶ **B32B 3/02; B41F 5/00**

A flexible medium for a scrolling color changer and method of making thereof. The medium is made by applying an ink using a Meyer Rod which has varying cell lengths along its length. This leaves varying size cells of ink at different locations along the length of the medium. The ink has special characteristics whereby its evaporation rate and viscosity are carefully controlled. The viscosity is such that an amount of levelling will occur will be equal to the distance between any cells, but that cell to cell levelling will not, in general, occur.

[52] **U.S. Cl.** **428/66.6; 428/66.5; 428/141; 428/156; 428/364; 428/398; 428/399; 101/329; 101/348; 492/30; 492/37**

[58] **Field of Search** 428/156, 36.9, 428/64.1, 66.5, 66.6, 131, 141, 212, 357, 364, 397, 398, 399; 492/30, 37; 72/180; 101/348, 329, 377; 172/537; 29/895, 895.32

[56] **References Cited**

U.S. PATENT DOCUMENTS

4,063,838 12/1977 Michael 428/367

6 Claims, 7 Drawing Sheets

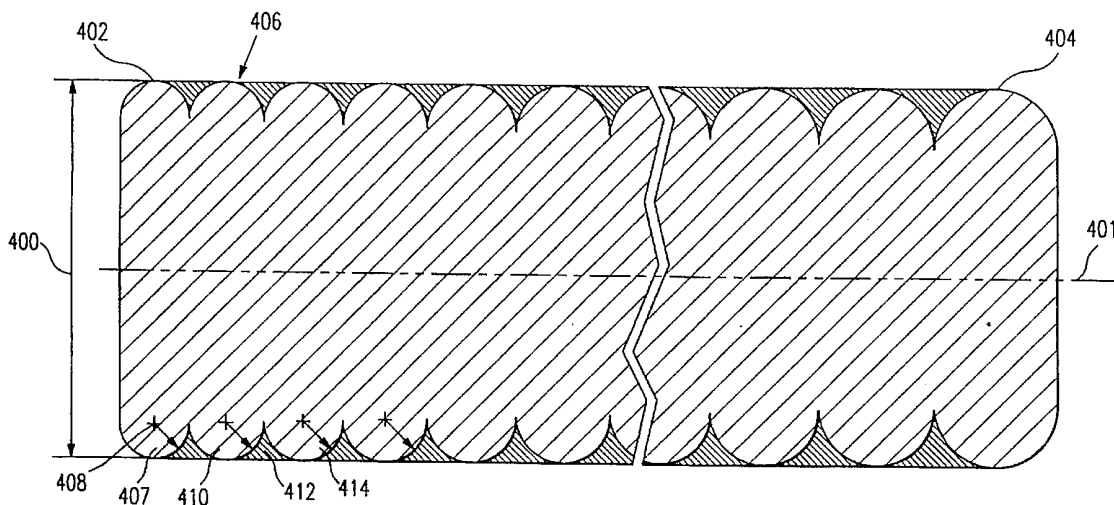

x = 0	x = .021	x = .044	x = .069
y = 0	y = .001	y = .002	y = .003
r = .010	r = .011	r = .012	r = .013

EXAMPLE ONLY

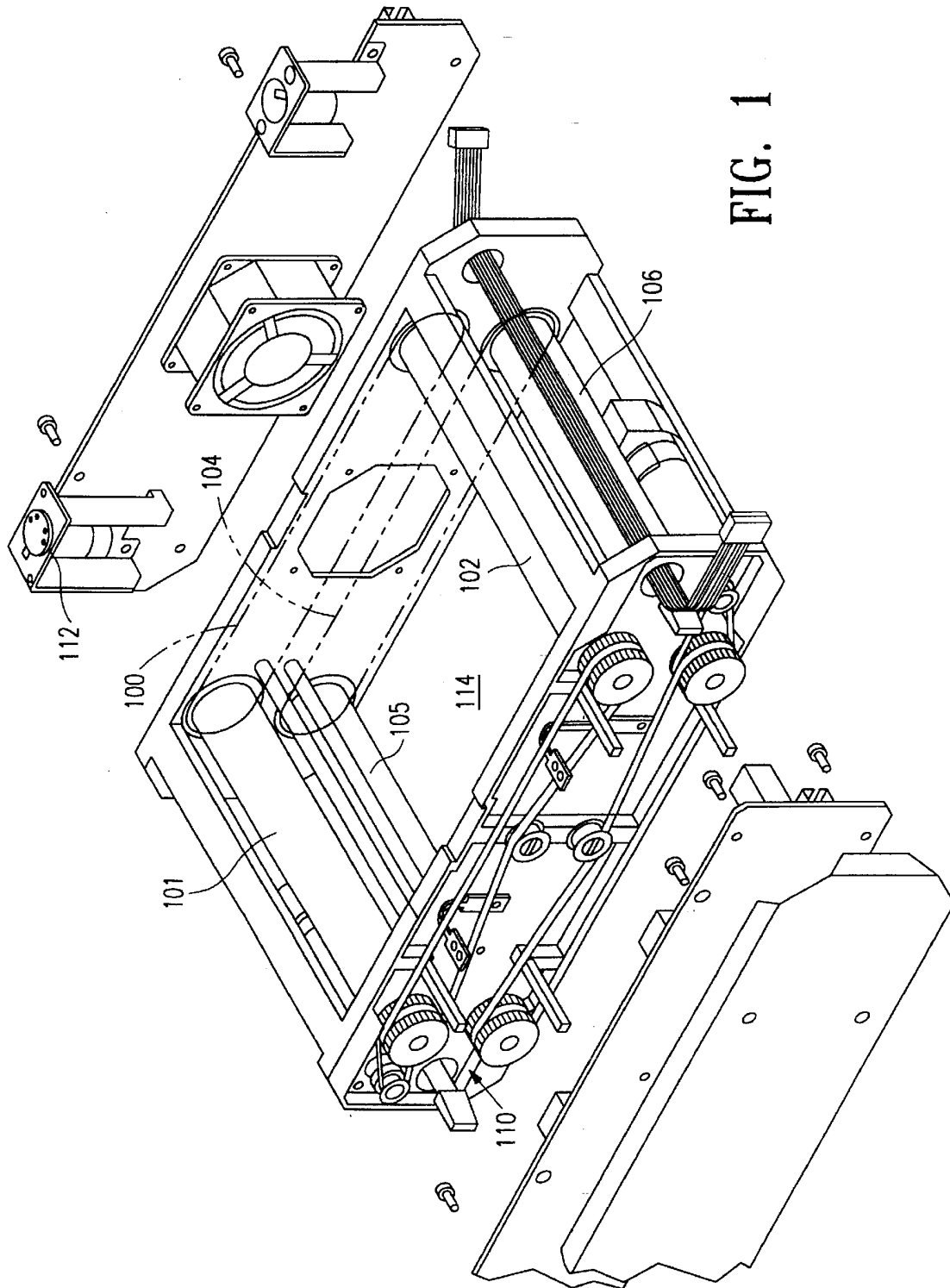

FIG. 1

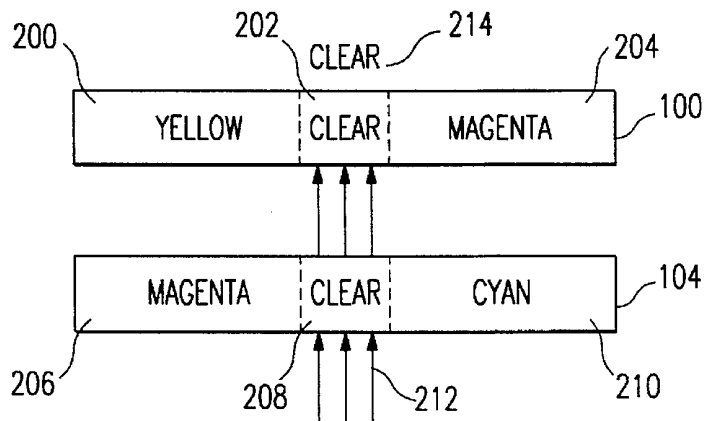

FIG. 2A

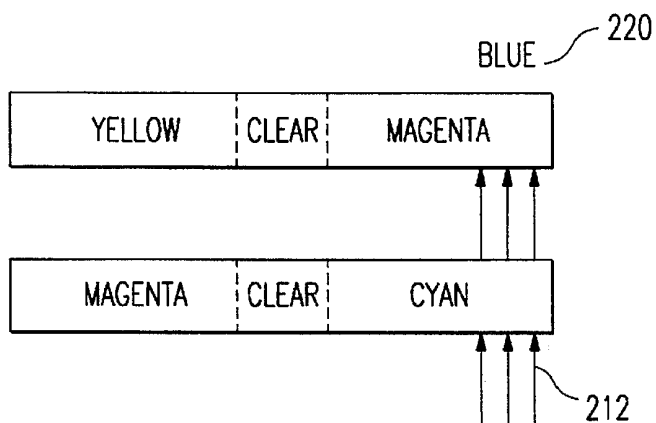

FIG. 2B

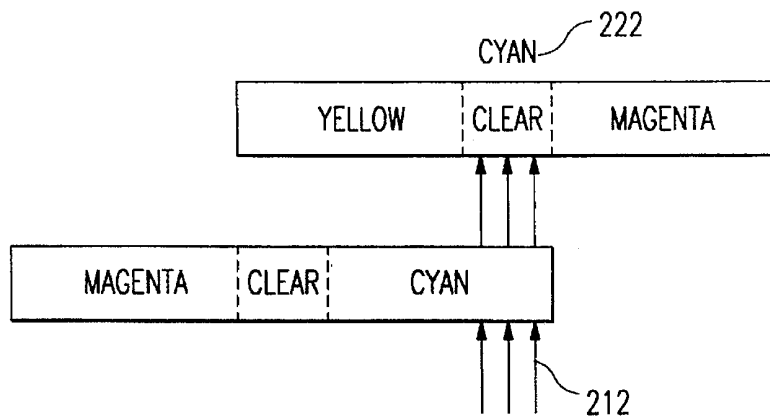

FIG. 2C

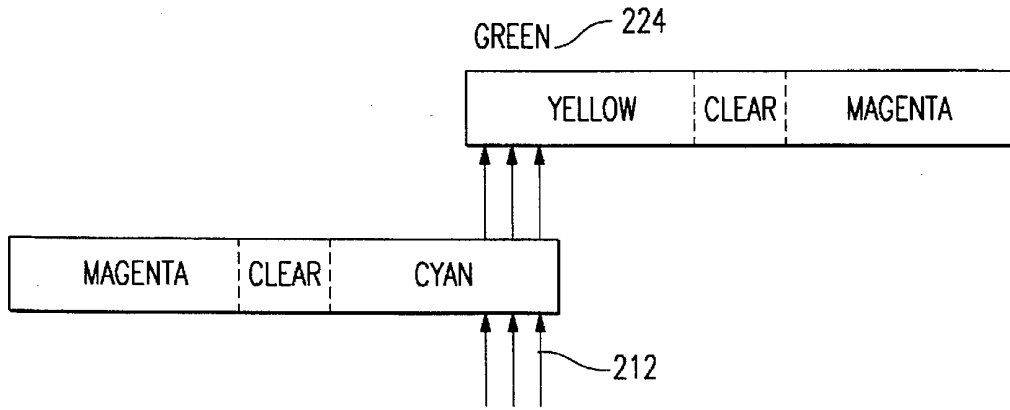

FIG. 2D

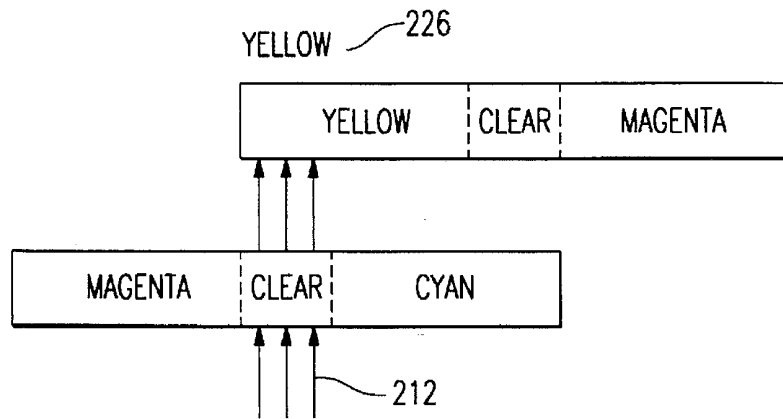

FIG. 2E

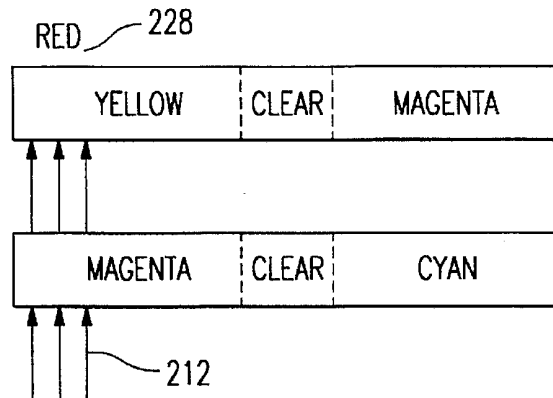

FIG. 2F

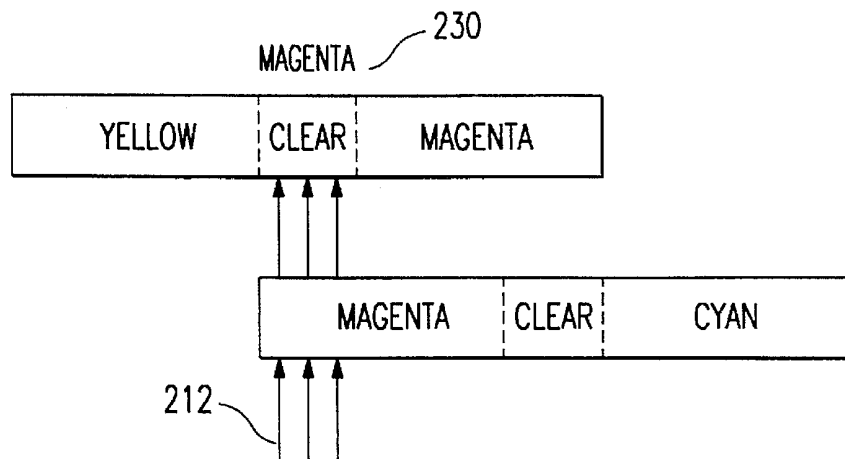

FIG. 2G

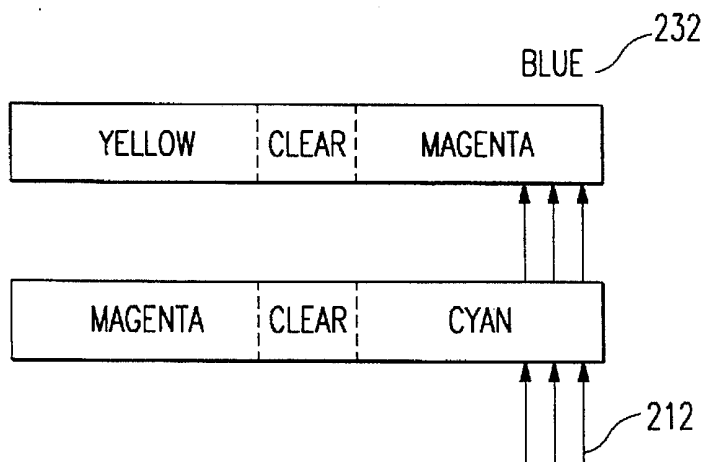

FIG. 2H

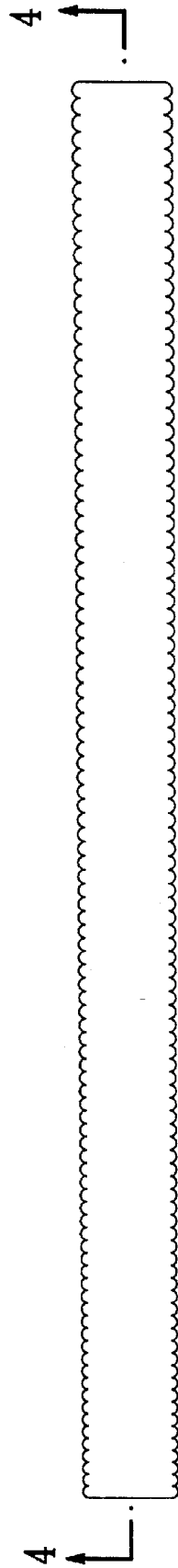
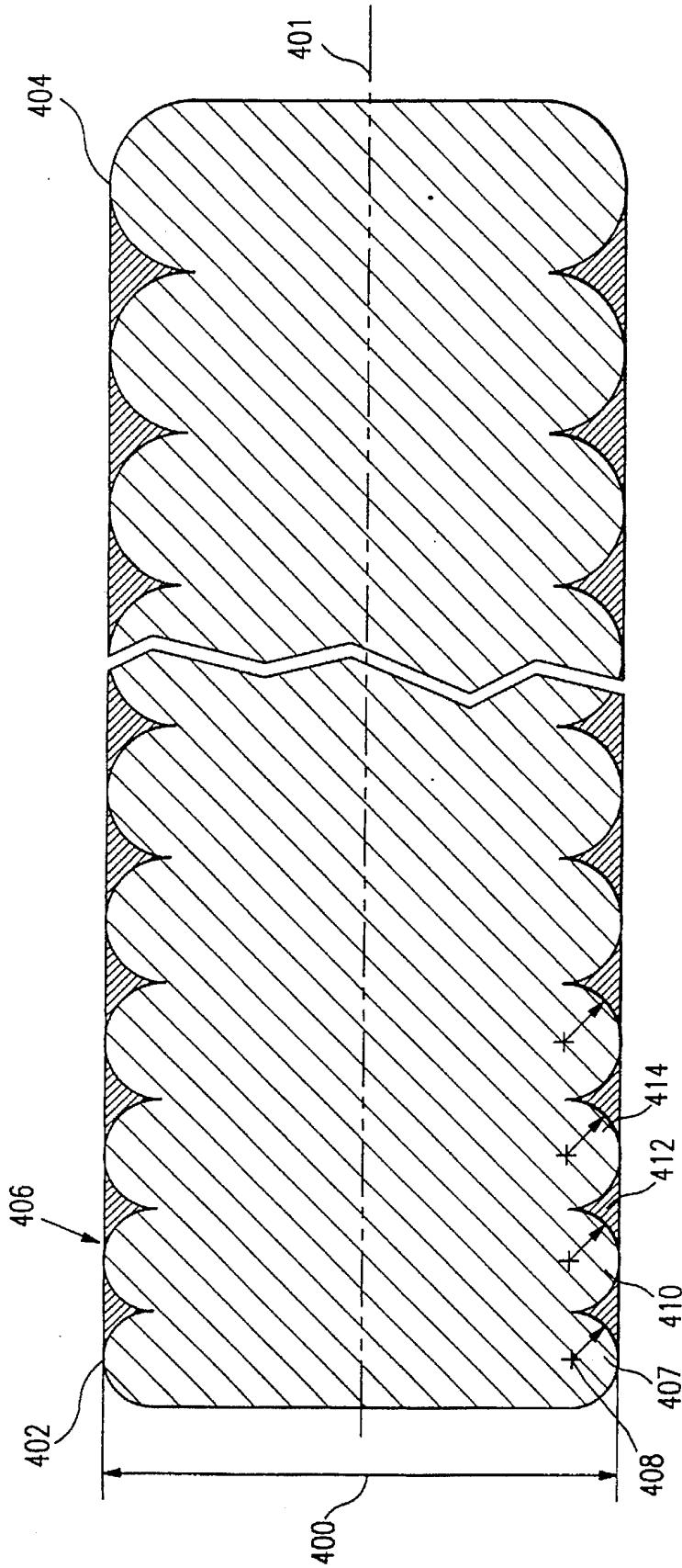

FIG. 3



x = 0	x = .021	x = .044	x = .069
y = 0	y = .001	y = .002	y = .003
r = .010	r = .011	r = .012	r = .013

EXAMPLE ONLY

FIG. 4

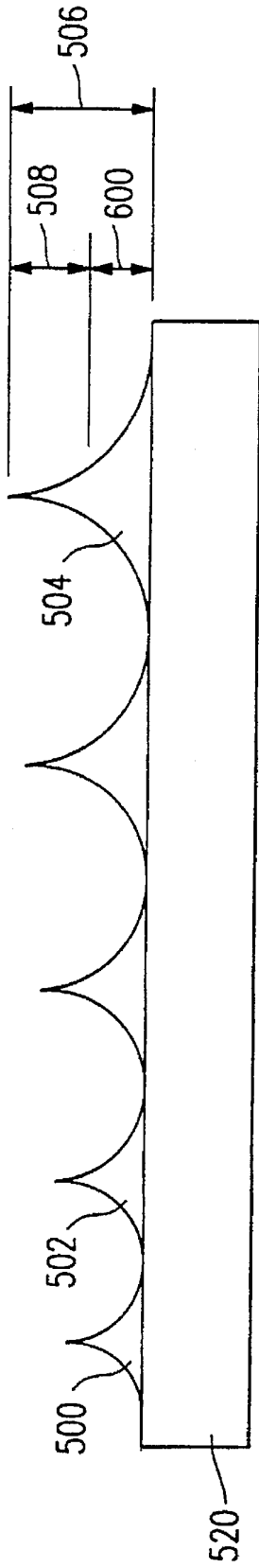

FIG. 5

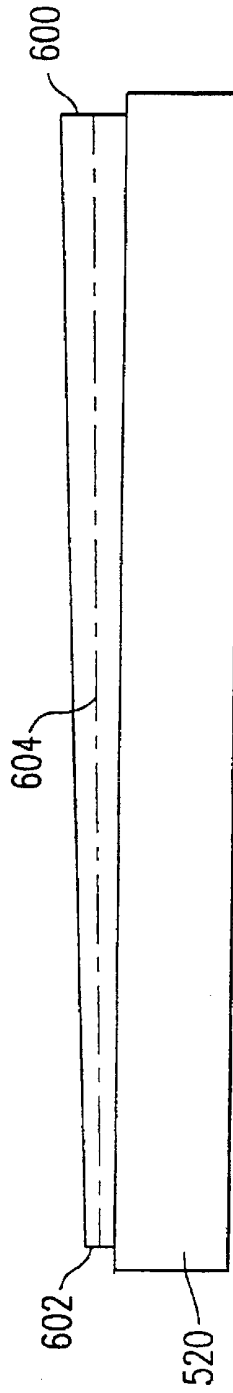

FIG. 6

MEDIUM FOR A COLOR CHANGER

BACKGROUND OF THE INVENTION

1. Field of the Invention

The present invention teaches an improved flexible medium for a scrolling-type color changer. More specifically, the present invention defines a color changer medium with continuously-variable characteristics across its length.

2. Background Information

Stage lighting systems project a beam of light which has been colored by a color filter. Different ways of coloring the light are known.

One way of coloring the light is by using dichroic filters such as taught in U.S. Pat. No. 4,800,474. This technique mounts a number of dichroic filters on rotatable color wheels. This system needs a large amount of space because the wheels must each have room for many filters to allow enough colors, and there must be room for the wheels to rotate.

Another way of coloring the light is by using a scrolling-type color changer such as that shown and described in U.S. Pat. No. 5,126,886, the disclosure of which is herewith incorporated by reference. Scrolling color changers move material between two scrolls to provide a desired filtering effect within the light path.

A problem occurs in determining how to appropriately change the color across the length of the color media of a scrolling changer. U.S. Pat. No. 5,126,886 demonstrates one conventional method of changing the color saturation across the length of the filter. A filter material is formed with a baseline saturation. A half-tone pattern is located thereon. This half-tone pattern provides a filtering effect which can be changed by adjusting the number of patterned elements per unit area.

SUMMARY OF THE INVENTION

The present invention goes against this established teaching by providing a continuously-varied color media. The color media is formed using a specially designed "Meyer Rod" to adjust the thickness of the coating deposited on the film.

The ink solution according to this invention has special characteristics of viscosity and evaporation rate. The viscosity is controlled such that ink in at least one of the cells flows to the next cell only, and not more than that amount, in the amount of time it takes the ink to dry. This forms a continuous coating that varies in thickness along a gradient axis.

Thicker coatings provide a more saturated color. The thickness of the coating is allowed to vary between cells, but does not vary across the width of the medium.

BRIEF DESCRIPTION OF THE DRAWINGS

These and other aspects of the invention will now be described in detail with reference to the accompanying drawings, wherein:

FIG. 1 shows the layout of the basic scrolling color chamber used to hold the medium made according to the present invention;

FIG. 2A-2H show various exemplary locations of the two scrolls used according to the present invention to obtain the most important colors;

FIG. 3 shows the preferred technique of applying the material to the substrate according to the present invention;

FIG. 4 shows a cross-sectional view of the Meyer Rod of FIG. 3 along the line 4-4;

FIG. 5 shows the interim product showing cells of ink on the substrate after the Meyer Rod has passed but before the cells have had time to level; and

FIG. 6 shows the final levelled product.

DESCRIPTION OF THE PREFERRED EMBODIMENT

FIG. 1 shows a basic scrolling color changer according to the present invention. More details about the operation of such a color changer are found in U.S. Pat. No. 5,126,886. The first media **100** of the color changer extends between roll **101** and roll **102**. The second media **104** extends between rolls **105** to **106**. The two rolls of either pair (**101/102** and **105/106**) are commonly controlled by gears, e.g., **110**, which allows both rolls to move in synchronism. By actuating motor **112**, for example, rolls **101** and **102** can be moved to quickly locate the color changer material to a desired location.

The beam of light is shown through location **114**, and adjusted by a combination of the two current positions of the scrolls. The color changing capability is obtained by various combinations of the colors in a conventional way.

FIGS. 2A-2H show the various ways in which the colors are obtained according to the present invention. Scroll **100** is shown at the top of each of FIGS. 2A-2H, and includes portions with varying saturations of yellow at a first end **200**, a clear portion in its center **202**, and varying saturations of magenta at a second end **204**. The second scroll **104** also includes magenta at a first end **206**, is clear in its center **208**, and cyan portions at the other end **210**. FIG. 2A shows the light beam **212** passing through the two clear portions to obtain a clear light beam **214**. FIG. 2B shows how cyan and magenta are combined to obtain blue light beam **220**. FIG. 2C shows cyan and clear being combined to obtain cyan light beam **222**. FIG. 2D shows cyan and yellow being combined to obtain a green color light beam **224**. FIG. 2E shows clear and yellow being combined to obtain a yellow light beam **226**. FIG. 2F shows magenta and yellow being combined to obtain red at **228**. FIG. 2G shows magenta and clear being combined to obtain magenta **230**, and finally, FIG. 2H shows cyan and magenta being combined to obtain another blue, **232**. The scrolls are appropriately positioned to obtain the desired color light.

The actual scroll material is formed of a polycarbonate, polyester or polypropylene film coated with a special colored ink. The colored ink has controlled evaporation and viscosity characteristics which allows continuous coating. For purposes of this specification, the term ink will be used to denote the material which is spread on the polypropylene backing sheet. Ink includes dye molecules, which form the color, in a binder which holds the dye molecules in solution, and a solvent. The ink binder is typically polyester. The dye molecules in the binder gives the material its final color. The solvent keeps the ink in a fluid state until the solvent evaporates. Therefore, when the solvent evaporates, the remaining dye molecules and binder are completely dried.

The polyester binder is in a solvent-based solution. The solvent includes Methyl Ethyl Ketone (MEK) and Toluene. The proportion of MEK to Toluene controls the rate of evaporation and levelling of the coating solution. The thickness of the ink on the polyester film controls the saturation of color; the thicker the coating, the more saturated the color becomes.

Any commercially available ink can be used if the viscosity of the solution and rate of evaporation is controlled.

The preferred inks used according to the present invention are described herein. The ink is applied in cells as described herein, and the viscosity of the ink solution is controlled such that the amount of ink levelling between cells which occurs in the amount of time that it takes the ink to dry, closely matches the distance between cells. For at least one of the cells, the amount of ink levelling before ink drying is precisely equal to the distance between cells.

The preferred embodiment of the present invention uses a specially-constructed Meyer Rod to apply the ink to the substrate. A prior art Meyer Rod used a stainless steel cylindrical rod with a stainless steel wire wrapped tightly around its circumference from one end to the other end. The space between adjacent wires holds ink. The amount of the coating deposit depends on the wire diameter or gauge. Typically, the coating is applied to the substrate by passing the substrate through a vat of ink solution, and then using different Meyer Rods to squeegee off all but the amount between the wires if the Meyer rod as the film passes by it. The space between the wire curvatures allows a specific amount of the solution to remain, and thereby leaves cells of material on the substrate. Different wire gauge Meyer Rods leave a different amount of solution on the substrate. Each Meyer Rod left a different thickness of material.

The present invention uses a Meyer Rod of a special type to spread the ink along the substrate material in a way that it continuously varies along a gradient axis thereof. I considered the idea of forming a Meyer Rod with varying diameter wire. However, I determined that constructing a Meyer Rod that used a length of wire with changing gauge would not be practical by itself since it would produce a conical rod which got larger as the gauge of the wire increased. I therefore decided to machine or precision grind a rod directly from stainless steel, simulating the changing wire curvature, but compensating for the changing radius to end up with a cylindrical form. I therefore invented the Meyer Rod which is shown in FIG. 3 with a cross-section along the line 4—4 being shown in FIG. 4.

FIG. 4 shows the overall diameter 400 of the rod which stays the same from its leftmost end 402 to its rightmost end 404. Overall diameter here refers to the diameter of the outermost edge of each section 406 relative to the central axis 401. However, the diameter of the various sections 406 vary from one end to the other. Each of the sections 406 is defined by three coordinates: x, y, and r. The origin is, for example, shown at point 408, in the center of the a smallest section 407. Hence, the section 407 has x,y coordinates 0,0, and a radius r of 0.10. The second Meyer Rod section 410 is at position 0.021, 0.001 with a radius 0.011. These values are just exemplary, and for a six inch rod, I would start with a radius of 0.025 inch, and increment each successive radius by 0.001 inch.

The Meyer Rod operates by allowing ink to remain only in the interstices 412 between two successive Meyer Rod portions, e.g. 410 and 414. As the portions get larger in radius, the amount of ink left by the interstices also gets larger. This means that the portions of ink deposited by the Meyer Rod at end 402 are smaller than the portions deposited at the end 404. Each portion of ink left by the area between two successive Meyer Rod sections will be referred to herein as a cell.

After the Meyer Rod has passed, the interim product is as shown in FIG. 5. A number of cells of ink remain on substrate 520. Each successive cell is slightly different in volume than the next cell. For example, cell 502 has slightly more volume than cell 500. Of course, FIG. 5 shows an exaggeration of this phenomena.

According to the present invention, I select inks which have a viscosity such that the amount of levelling between cells in the time it takes the ink to dry is equal to the levelling necessary for the two largest cells. More generally, however, the viscosity must be such that the amount of levelling in the time it takes the ink to dry is equal to the distance between any two desired cells. Height 600 shows the finally-levelled height at the highest end. Therefore, in the amount of time it takes the ink to dry, levelling by an amount of distance shown as 508, the distance between the highest level 504 and the final height 600, must occur. This may allow some cell-to-cell levelling in the smaller portions such as 500 and 502. However, this trade-off allows all portions to level somewhat, but still to form a material which is thicker at end 600 than it is at 602. It is most important that the cell-to-cell levelling be minimized so that the thickness, and hence color saturation, varies along the gradient axis 604. FIG. 6 shows the portions after levelling.

The characteristics of the ink are therefore crucial. The viscosity of the ink material is proportional to the solid content, to the dye and to the binder. It is also proportional to a ratio between the solids and the binder. The binder is typically a polyester material, such as Vitel (TM). I have used two preferred solvents, one of which is a combination of MEK and Toluene. The ratio between these two controls the amount of evaporation which occurs. I have also used a propylacetate solvent.

According to the present invention, the properties of the ink are controlled such that its viscosity is controlled relative to its evaporation time to provide a controlled amount of levelling. FIG. 6 shows the finally levelled product. In FIG. 6, the discontinuous portions such as 500 and 502 have been smoothed into a continuous portion. The height 600 is also shown in FIG. 5. The height 504 of portion 506 must be decreased by an amount 508 to level the final material at the height 600. Therefore, the viscosity of the material must be such that it can level by an amount 508 in the amount of time it takes for the solvent to evaporate. Some example formulations are described herein:

YELLOW

The "solids" portion of the yellow ink solution has the following make up:

8.5%	Yellow pigment 83 (C.I. #21108)
91.5%	Binder (Polyester Resin)

The "solvents" portion of the yellow ink solution has the following make up:

1.60%	Ethyl Alcohol
15.62%	Ethyl Acetate
21.67%	Toluene
21.97%	Isopropyl Alcohol
39.14%	Isopropyl Acetate

The "solids and "solvents" are combined in the ratio of:

25.91%	Solids (pigment/binder)
74.09%	Solvents

This solution will have a viscosity of 57 seconds measured with #2Z.

CYAN

The "solids" portion of the cyan ink solution has the following make up:

10.1%	Blue 15:4 (C.I. #74160)
0.1%	Violet 23 (C.I. #51319)
89.8%	Binder (Polyester Resin)

The "solvents" portion of the cyan ink solution has the following make up:

.26%	Ethyl Alcohol
.30%	Ethyl Acetate
1.73%	Isopropyl Alcohol
24.63%	Toluene
73.08%	Isopropyl Acetate

The "solids" and "solvents" are combined in the ratio of:

27.55%	Solids (pigment/binder)
72.45%	Solvents

This solution will have a viscosity of 37 seconds measured with #2Z.

MAGENTA

The "solids" portion of the magenta ink solution has the following make up:

9.6%	Rabine Red (C.I. #28620)
91.4%	Binder (Polyester Resin)

The "solvents" portion of the magenta ink solution has the following make up:

.24%	Ethyl Alcohol
.32%	Ethyl Acetate
1.54%	Isopropyl Alcohol
23.50%	Toluene
74.40%	Isopropyl Acetate

The "solids" and "solvents" are combined in the ratio of:

28.30%	Solids (pigment/binder)
71.70%	Solvents

This solution will have a viscosity of 65 seconds measured with #2Z.

Although only a few embodiments have been described in detail above, those having ordinary skill in the art will certainly understand that many modifications are possible in the preferred embodiment without departing from the teachings thereof.

All such modifications are intended to be encompassed within the following claims.

Although the present invention has been described using a Meyer Rod, it should be understood that other techniques

of ink imprintation of a backing material, including but not limited to a gravure cylinder and the like, could also be used for depositing the ink, so long as the ink is applied in cells, and allowed to level between the cells.

What is claimed is:

1. A Meyer Rod comprising a rod with a central axis, said rod including a plurality of sections collectively defining an outermost surface which has a substantially constant diameter defining a cylindrical shape, each said section having the shape of a portion of a circle, each said section having a radius, areas defined between adjacent ones of said sections defining fluid material holding surfaces and a first section of said Meyer Rod having a first radius and a second section of said Meyer Rod having a second radius different than said first radius, each of said first and second sections also having an outermost point where the section extends furthest away from the central axis, a distance between said outermost point of said first section and said central axis being the same as a distance between said outermost point of said second section and said central axis such that an overall diameter of said Meyer Rod remains constant, but diameters of said section vary in a way such that an ink holding surface at said first section is of different volume than an fluid material holding surface at said second section.

2. A Meyer Rod as in claim 1 wherein each radius of each section is different than a radius of any other section.

3. A device for use in application of fluid media to an object, comprising an fluid material removing rod, comprising a system which has adjacent outer surfaces collectively defining an overall outer surface which will abut against fluid material on the object and inner surfaces defined by surfaces between said outer surfaces, and wherein a volume of space between two adjacent ones of said inner surfaces forms an fluid material holding volume, an fluid material holding volume at a first end of the rod being different than an fluid material holding volume at a second end of the rod.

4. A device as in claim 3 wherein said volumes of said fluid material holding volumes vary continuously along the rod from one end to the other.

5. A device as in claim 3 wherein the fluid material removing rod is formed by a substantially conically-shaped inner rod, and a plurality of substantially-cylindrical elements wound around the conically-shaped inner rod, said cylindrical elements having a varying diameter, to provide a substantially constant outer diameter fluid material removing rod.

6. A device as in claim 3 wherein said fluid material removing rod includes a tapered inner diameter portion, and a varying diameter outer portion, said outer portion including portions which have a volume defined between surfaces thereof which volume is proportional to the diameter of the outer portion, the volume varying between one end of the fluid material removing rod and the other end of the fluid material removing rod.

* * * * *